

# Swiss Garde 360 Presence Slave 30 m

Czujnik obecności slave z obszarem detekcji o średnicy do 30 m, do montażu sufitowego podtynkowego

PIR



Czujnik obecności slave do zwiększania zasięgu czujników sufitowych i ściennych Swiss Garde Master.

Możliwy montaż natynkowy wraz z akcesoriami IP20/IP55.



## Zasięg

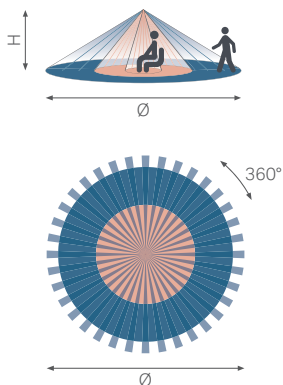

H	Ø	Ø
2 m	5 m	20 m
3 m	7 m	26 m
5 m	-	30 m
8 m	-	30 m

## Wymiary

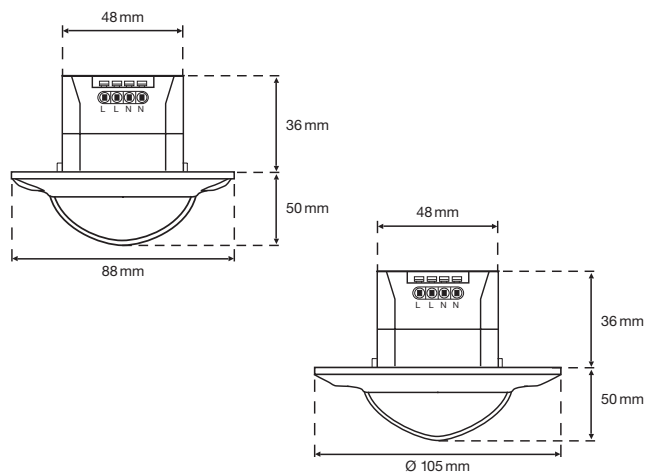

### Kod kreskowy



### Opis

Swiss Garde 360 Presence Slave 30 m, rund

### Kolor

biała

### Nr art.

25469



Swiss Garde 360 Presence Slave, 30 m

biała

25464







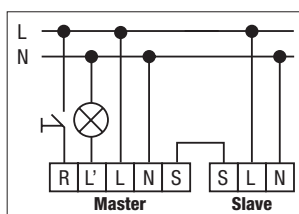









## Dane techniczne

Napięcie znamionowe	230 V ~ 50 Hz
Wysokość montażu	2 do 8 m
Obszar detekcji	360°
Zasięg	Obecność: Ø 7 m, ruch: Ø 26 m (przy 3 m wysokości)
Zakres temperatur	-20 do +40 °C

## Schemat podłączenia



## Akcesoria

		Obudowa natynkowa IP55, 360, 30 m, okrągła	biała	25264
		Obudowa podtynkowa IP55, 360, 30 m, okrągła	biała	25267
		Ramka kwadratowa natynkowa Swiss Garde	biała	25400
		Ramka okrągła natynkowa Swiss Garde	biała	25420
		Gniazdo montażowe z zaciskami sprężynowymi	przezroczyste	25411
		Universal RC z fotometrem	czarny	25323
		P-IR pilot	szary	25320
		Kratka ochronna	biała	3331