

3B

3-PHASE ECONOMICAL Π SECTION FILTER

FEATURES

- » Rated currents include **8A, 16A, 30A, 60A, 100A, 150A and 200A**
- » Single Stage Line Filter
- » Available with **QD** tabs or **S** (studs) option
- » Economical Design
- » Low Profile Case & Flange Mount Available
- » Agency Approved to UL E78081, CSA LR53652 and TUV
- » Y-cap value can be adjusted to fit specification

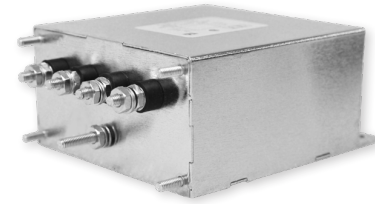

ELECTRICAL SCHEMATIC

DELTA - SUFFIX "D"

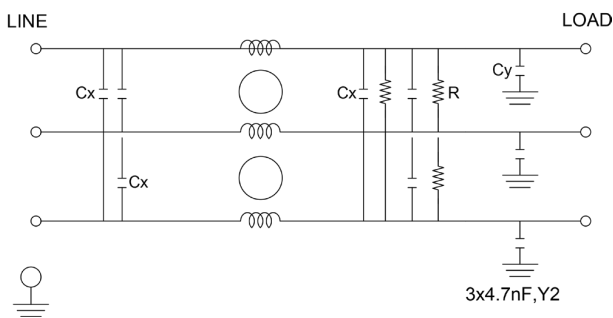

HOW TO ORDER

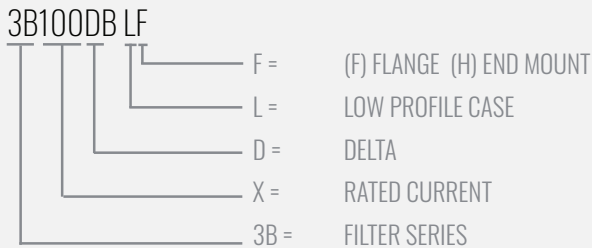

NOTE: USE ANY COMBINATION OF -X (AMPS) WITH ANY -Y RATINGS
E.G. **3B100DB LF** (100 AMPS, DELTA, LOW PROFILE CASE, FLANGE MOUNT)

SPECIFICATIONS

OPERATING FREQUENCY	50/60Hz
MAX. OPERATING VOLTAGE	250VAC +10% (DELTA) 440VAC + 10% (WYE)
TERMINALS (-T)	QD: 0.25" TABS STUDS: 8-32(8-30A), 1/4-20 (60A), 5/16-18 (100A), 3/8-16 (150-200A)
TYP. WEIGHT, LBS (KG)	0.81 - 11 (0.36 - 4.98)

TYPICAL LEAKAGE CURRENT

@ 250 VAC 50 Hz 0 - 2.80 mA Max.

HIPOT RATINGS

LINE TO GROUND 2700 VDC - 3200 VDC

TYPICAL APPLICATIONS

- ✓ High Power Rectifiers
- ✓ Uninterrupted Power Supplies
- ✓ Processing Equipment
- ✓ Alternative Energy (EV Charging & Solar)
- ✓ Factory Machinery

3B

3-PHASE ECONOMICAL Π SECTION FILTER

MODEL NO.	RATED CURRENT (A) @ 40° C	Y-CAP, nF	LEAKAGE CURRENT, mA @ 250V AC, 50 Hz /	TERMINAL OPTIONS		MAX. DIMENSIONS" (MM)		
				(QD) INPUT/ OUTPUT	(S) INPUT/ OUTPUT	WIDTH	(LENGTH)	HEIGHT
3B8	8	4x.0047 μ F	.80	✓		2.12"(54)	4.11"(105)	1.79"(46)"
3B8D	8	3x.0047 μ F	.80	✓		2.12"(54)	4.11"(105)	1.79"(46)"
3B8D S	8	3x.0047 μ F	.80		✓	2.12"(54)	4.11"(105)	1.79"(46)"
3B16	16	4x.01 μ F	1.4	✓		2.88"(73)	4.33"(110)	2.04"(52)"
3B16D	16	3x.01 μ F	1.4	✓		2.88"(73)	4.33"(110)	2.04"(52)"
3B16D S	16	3x.01 μ F	1.4		✓	2.88"(73)	4.33"(110)	2.04"(52)"
3B30	30	4x.01 μ F	1.4		✓	4.12"(105)	5.24"(133)	1.79"(45.5)
3B30 L	30	*	1.4	*	*	4.12"(105)	5.24"(133)	1.79"(45.5)
3B30 LF	30	4x.01 μ F	1.4		✓	4.12"(105)	5.24"(133)	1.79"(45.5)
3B30D	30	3x.01 μ F	1.4		✓	4.12"(105)	5.24"(133)	1.79"(45.5)
3B30DB	30	3x.022 μ F	2.8		✓	4.12"(105)	5.24"(133)	1.79"(45.5)
3B60 L	60	*	1.4	*	*	4.25"(108)	8.14"(207)	2.25"(57)
3B60 LF	60	4x.01 μ F/4x.01 μ F	1.4		✓	4.25"(108)	8.14"(207)	2.25"(57)
3B60B LF	60	4x.001 μ F/4x.022 μ F	1.4		✓	4.25"(108)	8.14"(207)	2.25"(57)
3B60D L	60	*	1.4	*	*	4.25"(108)	8.14"(207)	2.25"(57)
3B60D LF	60	3x.01 μ F	1.4		✓	4.25"(108)	8.14"(207)	2.25"(57)
3B60D LH	60	3x.01 μ F	1.4		✓	4.25"(108)	8.14"(207)	2.25"(57)
3B100 L	100	*	1.4	*	*	5.50"(140)	8.87"(225)	3.00"(76)
3B100 LF	100	4x.01 μ F	1.4		✓	5.50"(140)	8.87"(225)	3.00"(76)
3B100B LF	100	4x.022 μ F	1.4		✓	5.50"(140)	8.87"(225)	3.00"(76)
3B100D L	100	*	2.1	*	*	5.50"(140)	8.87"(225)	3.00"(76)
3B100D LF	100	3x.015 μ F	2.1		✓	5.50"(140)	8.87"(225)	3.00"(76)
3B100DB LF	100	4x.022 μ F	3.1		✓	5.50"(140)	8.87"(225)	3.00"(76)
3B150	150	*	2.1	*	*	5.00"(127)	10.00"(254)	4.75"(121)
3B150D	150	*	2.1	*	*	5.00"(127)	10.00"(254)	4.75"(121)
3B150D H	150	3x.015 μ F	2.1		✓	5.00"(127)	10.00"(254)	4.75"(121)
3B150DB F	150	3x.022 μ F	2.1		✓	5.00"(127)	10.00"(254)	4.75"(121)
3B200	200	*	2.1	*	*	*	*	*

*Contact factory for dimensions.

3B

3-PHASE ECONOMICAL Π SECTION FILTER

3B MECHANICAL OUTLINES (MM)

QD TABS (8AMPS)

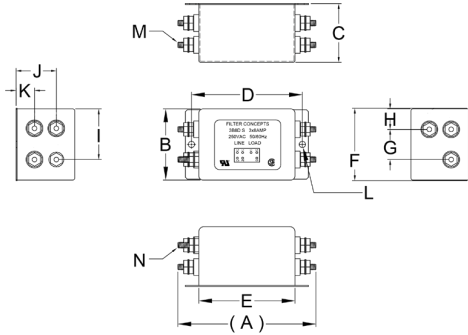

STUDS (16 AMPS)

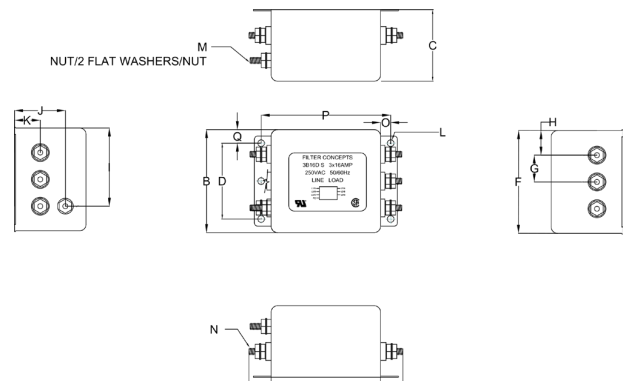

STUDS (30 AMPS)

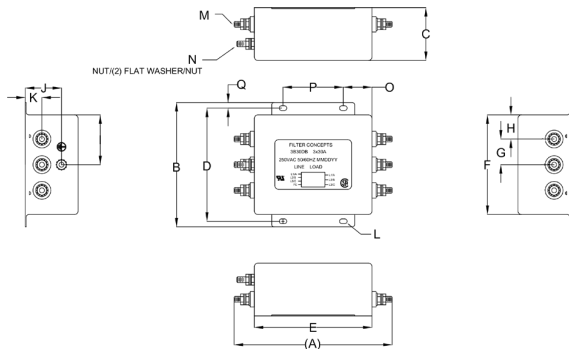

STUDS (60 AMPS)

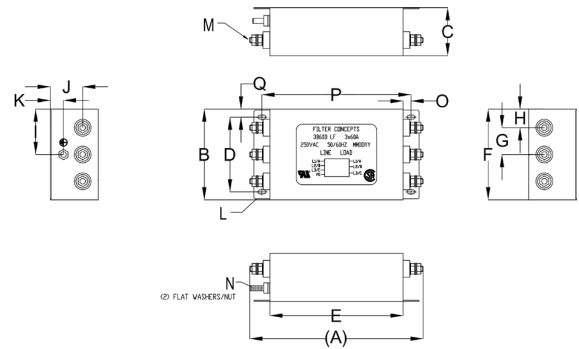

STUDS (100-150 AMPS)

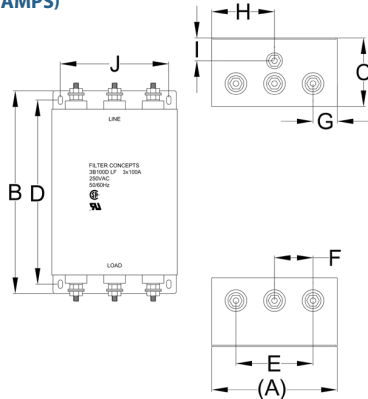

3B

3-PHASE ECONOMICAL Π SECTION FILTER

SERIES	(A)	B	C	D	E	F	G	H	I	J	K	L	M	N	O	P	Q
8 amps	4.11" (105)	2.12" (54)	1.79" (46)	3.31" (84)	2.87" (73)	2.18" (55)	0.90" (23)	0.61" (16)	1.55" (39)	1.20" (31)	0.55" (14)	0.18",2x Ø4.75, 2x	STUD, 8-32, 6x	STUD, GND, 8-32	N/A	N/A	N/A
16 amps	4.33" (110)	2.88" (73)	2.04" (52)	2.12" (54)	3.06" (78)	2.87" (73)	0.75" (19)	0.69" (18)	2.19" (56)	1.42" (36)	0.72" (18)	0.18",6x Ø4.7, 6x	STUD, 8-32, 6x	STUD, GND, 8-32	0.28" (7)	3.62" (92)	0.38" (10)
30 amps	5.24" (133)	4.12" (105)	1.79" (45.5)	3.75" (95)	3.90" (99)	3.30" (84)	0.85" (22)	0.80" (20)	1.65" (42)	1.20" (30)	0.55" (14)	0.15"x0.25",4x Ø 4.0x6.35, 4x	STUD, 8-32, 6x	STUD, GND, 8-32	0.95" (24)	2.00" (51)	0.19" (5)
60 amps	8.14" (207)	4.25" (108)	2.25" (57)	3.50" (89)	6.25" (159)	4.25" (108)	1.26" (32)	0.87" (22)	2.13" (54)	1.52" (39)	0.62" (16)	0.37"x0.18",4x Ø 9.5x4.8, 4x	STUD, 1/4-20, 6x	STUD, GND, 1/4-20	0.37" (10)	7.00" (178)	0.37" (9)
100 amps	5.50" (140)	8.87" (225)	3.00" (76)	8.06" (205)	3.38" (86)	1.70" (43)	1.06" (27)	2.75" (70)	1.00" (25)	4.74" (120)	N/A	N/A	N/A	N/A	N/A	N/A	N/A
150 amps	5.00" (127)	10.00" (254)	4.75" (121)	8.89" (226)	3.00" (76)	1.50" (38)	1.00" (25)	2.50" (64)	1.30" (33)	4.00" (102)	N/A	N/A	N/A	N/A	N/A	N/A	N/A

TYPICAL TOLERANCE: +/-0.02" (0.50MM)

TYPICAL INSERTION LOSS, dB (50/50 Ohm)

Amps	Freq (MHz)	0.01	0.15	0.5	1.0	10	30
3B8D	CM (dB)	6	6	50	39	56	63
	DM (dB)	18	18	38	35	53	62
3B8D S	CM (dB)	6	6	50	39	56	63
	DM (dB)	18	18	38	35	53	62
3B8	CM (dB)	17	17	35	39	56	63
	DM (dB)	18	18	38	35	53	62
3B16D	CM (dB)	20	20	50	39	56	63
	DM (dB)	18	18	38	35	53	62
3B16D S	CM (dB)	20	20	50	39	56	63
	DM (dB)	18	18	38	35	53	62
3B16	CM (dB)	20	20	40	39	56	63
	DM (dB)	18	18	38	35	53	62
3B30D	CM (dB)	20	20	50	39	56	63
	DM (dB)	18	18	38	35	53	62
3B30DB	CM (dB)	20	20	50	39	56	63
	DM (dB)	21	21	42	35	53	62
3B30	CM (dB)	20	20	40	39	56	63
	DM (dB)	18	18	38	35	53	62

3B

3-PHASE ECONOMICAL Π SECTION FILTER

Amps	Freq (MHz)	0.01	0.15	0.5	1.0	10	30
3B30 LF	CM (dB)	20	20	40	39	56	63
	DM (dB)	18	18	38	35	53	62
3B30B LF	CM (dB)	20	20	40	39	56	63
	DM (dB)	18	18	38	35	53	62
3B30 L	CM (dB)	20	20	40	39	56	63
	DM (dB)	18	18	38	35	53	62
3B60D LF	CM (dB)	30	30	60	39	56	63
	DM (dB)	18	18	35	35	53	62
3B60B LF	CM (dB)	20	20	40	39	56	63
	DM (dB)	18	18	38	35	53	62
3B60 LF	CM (dB)	20	20	60	39	56	63
	DM (dB)	22	22	40	35	53	62
3B60 L	CM (dB)	20	20	40	39	56	63
	DM (dB)	18	18	38	35	53	62
3B60D L	CM (dB)	20	20	40	39	56	63
	DM (dB)	18	18	38	35	53	62
3B100D LF	CM (dB)	30	30	50	39	56	63
	DM (dB)	18	18	34	35	53	62
3B100 LF	CM (dB)	30	30	60	39	56	63
	DM (dB)	17	17	40	35	53	62
3B100B LF	CM (dB)	30	30	60	39	56	63
	DM (dB)	20	20	43	35	53	62
3B100DB LF	CM (dB)	30	30	50	39	56	63
	DM (dB)	21	21	37	35	53	62
3B100 L	CM (dB)	20	20	40	39	56	63
	DM (dB)	18	18	38	35	53	62
3B100D L	CM (dB)	20	20	40	39	56	63
	DM (dB)	18	18	38	35	53	62
3B150D H	CM (dB)	48	48	65	39	56	63
	DM (dB)	18	18	38	35	53	62
3B150DB F	CM (dB)	20	20	40	39	56	63
	DM (dB)	18	18	38	35	53	62
3B150	CM (dB)	20	20	40	39	56	63
	DM (dB)	18	18	38	35	53	62

3B

3-PHASE ECONOMICAL Π SECTION FILTER

Amps	Freq (MHz)	0.01	0.15	0.5	1.0	10	30
3B150D	CM (dB)	20	20	40	39	56	63
	DM (dB)	18	18	38	35	53	62
3B200	CM (dB)	20	20	40	39	56	63
	DM (dB)	18	18	38	35	53	62