

3F

HIGH PERFORMANCE 3-PHASE SWITCH MODE EMI FILTER

FEATURES

- » Rated currents include **3A, 7.5A, 15A, 30A, 45A, 60A, 80A, 100A, and 150A**
- » Dual Stage Line Filter
- » Available with **QD** (tabs) and **S** (studs) option
- » Low Profile Case, End Mount Case & Flange Mount Available
- » Y-cap value can be adjusted to fit specification



ELECTRICAL SCHEMATIC

DELTA - SUFFIX "D"

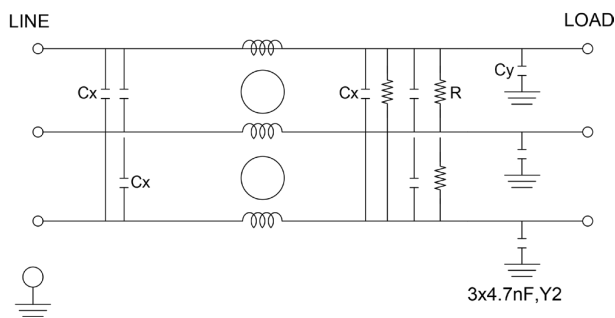

SPECIFICATIONS

OPERATING FREQUENCY	50/60HZ
USABLE FREQUENCY	
MAX. OPERATING VOLTAGE*	250VAC +10%
AMBIENT TEMPERATURE	
CLIMATIC CATEGORY	
TERMINALS (-T)	QD: 0.25 TABS STUDS: 8-32 (7.5A), 10-32(15-45A), 1/4-20 (60A-100A), 3/16-18 (80A)
TYP. WEIGHT, LBS (KG)	1.3-32 (.589-14.515)

LEAKAGE CURRENT

@ 250 VAC 60 HZ	2.4 mA Max.
-----------------	-------------

HIPOT RATINGS

LINE TO GROUND	2200 VDC - 3200 VDC
----------------	---------------------

TYPICAL APPLICATIONS

- ✓ High Power Rectifiers
- ✓ Uninterrupted Power Supplies
- ✓ Processing Equipment
- ✓ Alternative Energy (EV Charging & Solar)
- ✓ Factory Machinery

HOW TO ORDER

3F15 L F

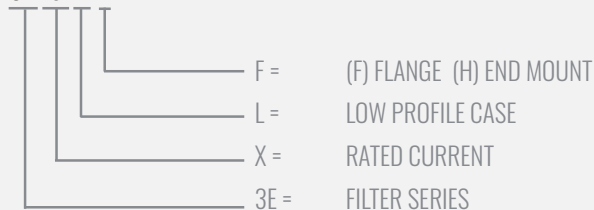

NOTE: USE ANY COMBINATION OF -X (AMPS) WITH ANY -Y RATINGS
E.G. **3F15 LF**(15 AMPS, LOW PROFILE CASE, FLANGE MOUNT)

3F

HIGH PERFORMANCE 3-PHASE SWITCH MODE EMI FILTER

MODEL NO.	RATED CURRENT (A) @ 40° C	Y-CAP, nF	LEAKAGE CURRENT, mA @ 250V AC, 50 Hz	TERMINAL OPTIONS		MAX. DIMENSIONS" (MM)		
				(QD) INPUT/ OUTPUT	(S) INPUT/ OUTPUT	WIDTH	(LENGTH)	HEIGHT
3F3	3	4x.0047µF	.80	✓		2.88"(73)	4.06"(103)	2.00"(51)
3F3D	3	3x.0047µF	.80	✓		2.88"(73)	4.06"(103)	2.00"(51)
3F7	7.5	*	.80	*	*	3.00"(76)	6.24"(158)	3.00"(76)
3F7 F	7.5	4x.0047µF	.80		✓	3.00"(76)	6.24"(158)	3.00"(76)
3F7 L	7.5	*	.80	*	*	3.00"(76)	6.24"(158)	3.00"(76)
3F7A H	7.5	4x.0047µF/4x.0022µF	.80		✓	3.00"(76)	6.24"(158)	3.00"(76)
3F7D F	7.5	3x.0047µF	.80		✓	3.00"(76)	6.24"(158)	3.00"(76)
3F15	15	*	.80	*	*	4.00"(102)	8.62"(219)	4.00"(102)
3F15 F	15	4x.0047µF	.80		✓	4.00"(102)	8.62"(219)	4.00"(102)
3F15 L	15	*	.80	*	*	4.00"(102)	8.62"(219)	4.00"(102)
3F15 LF	15	4x.0047µF	.80		✓	4.00"(102)	8.62"(219)	4.00"(102)
3F15D F	15	3x.0047µF	.80		✓	4.00"(102)	8.62"(219)	4.00"(102)
3F30	30	*	1.4	*	*	5.00"(127)	9.96"(253)	4.75"(121)
3F30 F	30	4x.01µF	1.4		✓	5.00"(127)	9.96"(253)	4.75"(121)
3F30 H	30	4x.01µF	1.4		✓	5.00"(127)	9.96"(253)	4.75"(121)
3F30 L	30	*	1.4	*	*	5.00"(127)	9.96"(253)	4.75"(121)
3F30 LF	30	4x.01µF	1.4		✓	5.00"(127)	9.96"(253)	4.75"(121)
3F30A F	30	4x.01µF/4x.0047µF	2.1		✓	5.00"(127)	9.96"(253)	4.75"(121)
3F30A H	30	4x.01µF/4x.0047µF	2.1		✓	5.00"(127)	9.96"(253)	4.75"(121)
3F30D LF	30	3x.01µF	1.4		✓	5.00"(127)	9.96"(253)	4.75"(121)
3F30DA H	30	3x.01µF/3x.0047µF	2.1		✓	5.00"(127)	9.96"(253)	4.75"(121)
3F45	45	*	1.4	*	*	5.00"(127)	12.96"(329)	4.74"(120)
3F45 F	45	4x.01µF	1.4		✓	5.00"(127)	12.96"(329)	4.74"(120)
3F60	60	*	1.6	*	*	6.50"(165)	14.00"(356)	4.75"(121)
3F60 F	60	4x.01µF	1.6		✓	6.50"(165)	14.00"(356)	4.75"(121)
3F60A H	60	4x.01µF/4x.0047µF	1.6		✓	6.50"(165)	14.00"(356)	4.75"(121)
3F60D F	60	3x.01µF	1.2		✓	6.50"(165)	14.00"(356)	4.75"(121)
3F80	80	*	2.4	*	*	6.50"(165)	17.00"(432)	4.75"(121)
3F80D	80	*	2.4	*	*	6.50"(165)	17.00"(432)	4.75"(121)
3F80D F	80	3x.015µF	2.4		✓	6.50"(165)	17.00"(432)	4.75"(121)
3F100	100	*	2.4	*	*	7.50"(191)	17.50"(445)	5.75"(146)
3F100D	100	*	2.4	*	*	7.50"(191)	17.50"(445)	5.75"(146)
3F100D H	100	3x.022µF	2.4		✓	7.50"(191)	17.50"(445)	5.75"(146)
3F150	150	*	.80	*	*	7.50"(191)	17.50"(445)	5.75"(146)

*Contact factory for dimensions.

3F

HIGH PERFORMANCE 3-PHASE SWITCH MODE EMI FILTER

3F MECHANICAL OUTLINES (MM)

STUDS (3 AMPS)

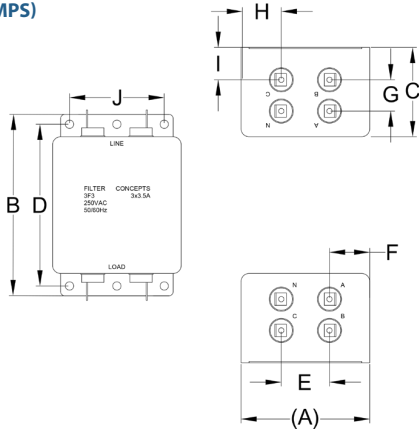

STUDS (7.5 AMPS)

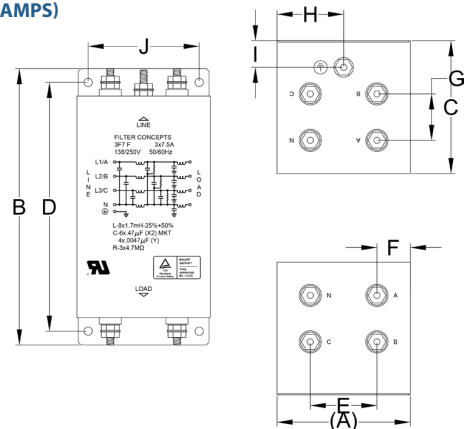

STUDS (15/60/80 AMPS)

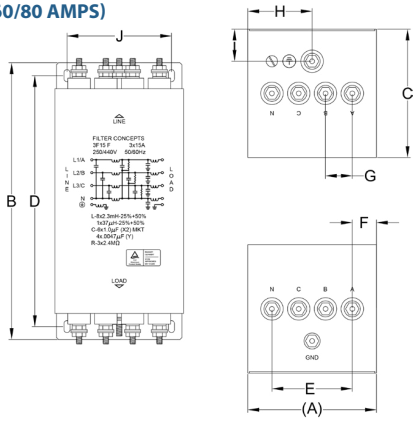

STUDS (30/45 AMPS)

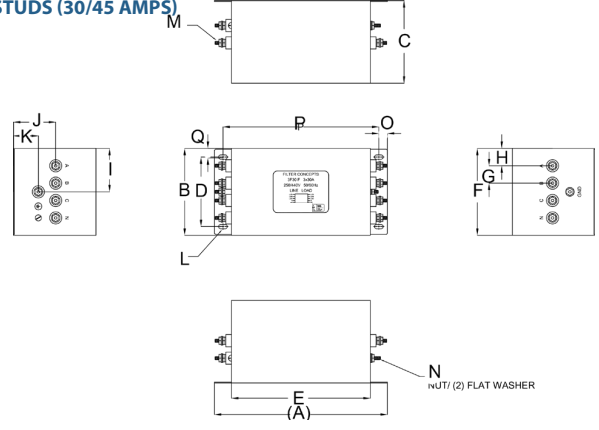

STUDS (100/150 AMPS)

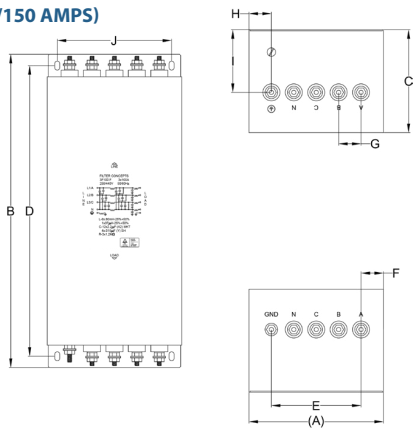

3F

HIGH PERFORMANCE 3-PHASE SWITCH MODE EMI FILTER

SERIES	(A)	B	C	D	E	F	G	H	I	J	K	L	M	N	O	P	Q
3 amps	2.88" (73)	4.06" (103)	2.00" (51)	3.62" (92)	1.08" (27)	0.90" (23)	0.70" (18)	0.87" (22)	0.73" (18)	2.12" (54)	N/A	N/A	N/A	N/A	N/A	N/A	N/A
7.5 amps	3.00" (76)	6.24" (158)	3.00" (76)	5.62" (143)	1.50" (38)	0.75" (19)	1.05" (27)	1.50" (38)	0.60" (15)	2.50" (64)	N/A	N/A	N/A	N/A	N/A	N/A	N/A
15 amps	4.00" (102)	8.62" (219)	4.00" (102)	7.82" (199)	2.50" (64)	0.75" (19)	0.83" (21)	2.00" (51)	1.00" (25)	3.25" (83)	N/A	N/A	N/A	N/A	N/A	N/A	N/A
30 amps	9.96" (253)	5.00" (127)	4.75" (121)	4.00" (102)	8.00" (203)	5.00" (127)	1.00" (25)	1.00" (25)	2.50" (64)	2.43" (62)	1.43" (36)	Ø 12.7x6.4, 4x	STUD, 10-32, 9x	STUD, GND, 10-32	0.49" (12)	8.98" (228)	0.55" (14)
45 amps	12.96" (329)	5.00" (127)	4.74" (120)	4.00" (102)	10.90" (277)	5.00" (127)	1.00" (25)	1.00" (25)	2.50" (64)	2.43" (62)	1.43" (36)	Ø 0.25x0.50, 4x	STUD #10-32, 9x	STUD GND #10-32	0.49" (12)	11.89" (302)	0.50" (13)
60 amps	6.50" (165)	14.00" (356)	4.75" (121)	13.00" (330)	3.38" (86)	1.56" (40)	1.13" (29)	3.25" (83)	1.43" (36)	4.25" (108)	N/A	N/A	N/A	N/A	N/A	N/A	N/A
80 amps	6.50" (165)	17.00" (432)	4.75" (121)	16.00" (406)	3.38" (86)	1.56" (40)	1.13" (29)	3.25" (83)	1.43" (36)	4.25" (108)	N/A	N/A	N/A	N/A	N/A	N/A	N/A
100/150 amps	7.50" (191)	17.50" (445)	5.75" (146)	16.24" (412)	5.00" (127)	1.13" (29)	1.13" (29)	1.25" (32)	3.50" (89)	6.37" (162)	N/A	N/A	N/A	N/A	N/A	N/A	N/A

TYPICAL TOLERANCE: +/-0.02" (0.50MM)

TYPICAL INSERTION LOSS, dB (50/50 Ohm)

Amps	Freq (MHz)	Insertion Loss (dB)				
		0.15	0.5	1.0	10	30
3	CM (dB)	35	60	51	63	69
	DM (dB)	60	60	53	69	77
7.5	CM (dB)	50	60	51	63	69
	DM (dB)	50	65	53	69	77
15	CM (dB)	50	60	51	63	69
	DM (dB)	50	65	53	69	77
30	CM (dB)	45	60	51	63	69
	DM (dB)	50	65	53	69	77
45	CM (dB)	50	60	51	63	69
	DM (dB)	50	65	53	69	77
60	CM (dB)	50	60	51	63	69
	DM (dB)	50	65	53	69	77
80	CM (dB)	50	60	51	63	69
	DM (dB)	50	65	53	69	77

3F

HIGH PERFORMANCE 3-PHASE SWITCH MODE EMI FILTER

Amps	Freq (MHz)	0.15	0.5	1.0	10	30
100	CM (dB)	50	60	51	63	69
	DM (dB)	50	65	53	69	77
150	CM (dB)	50	60	51	63	69
	DM (dB)	50	65	53	69	77