

Synthetic reduction fittings

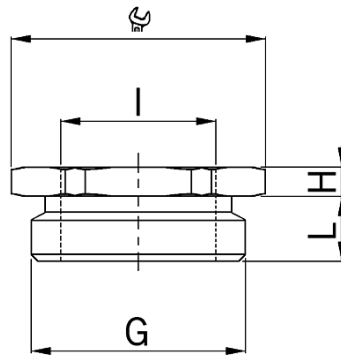

- **Material:** Polyamide glass fiber reinforced
- **minimal operation temperature:** -20°C
- **maximum operation temperature:** +100°C
- **Protection class:** IP 54
- **Further protection:** IP 68, if the entry thread is sealed

- hexagonal
- Outer thread Pg
- Inner thread Pg
- Light grey

- **Thread outside:** Pg 16
- **Internal thread:** Pg 11
- **Wrench size:** 27 mm
- **Dimension H:** 5 mm
- **Dimension L:** 9 mm

Art. No.: 3416.11

- **E-No.:** 126 341 042
- **Inner packaging:** ST
- **Outer packaging:** 50 ST
- **Individual net weight:** 5,220 G
- **EAN:** 7611614011523
- **ETIM40:** EC001469