

Synthetic reduction fittings

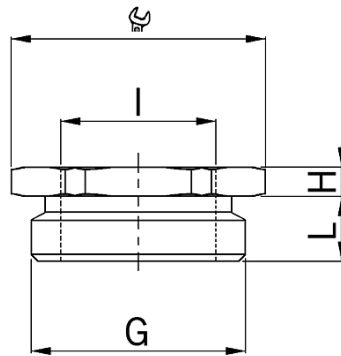

- **Material:** Polyamide glass fiber reinforced
- **minimal operation temperature:** -20°C
- **maximum operation temperature:** +100°C
- **Protection class:** IP 54
- **Further protection:** IP 68, if the entry thread is sealed

- hexagonal
- Outer thread Pg
- Inner thread Pg
- Light grey

- **Thread outside:** Pg 21
- **Internal thread:** Pg 13
- **Wrench size:** 32 mm
- **Dimension H:** 5 mm
- **Dimension L:** 11 mm

Art. No.: 3421.13

- **E-No.:** 126 341 053
- **Inner packaging:** ST
- **Outer packaging:** 25 ST
- **Individual net weight:** 8,960 G
- **EAN:** 7611614011547
- **ETIM40:** EC001469