

Synthetic reduction fittings

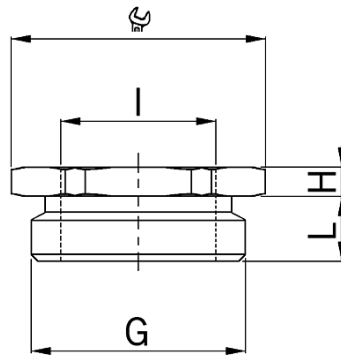

- **Material:** Polyamide PA 6
- **Properties:** halogen-free
- **minimal operation temperature:** -30°C
- **maximum operation temperature:** +100°C
- **Protection class:** IP 54
- **Further protection:** IP 68, if the entry thread is sealed

- hexagonal
- Outer thread metric
- Inner thread metric
- Light grey RAL 7035

- **Thread outside:** M20x1.5
- **Internal thread:** M16x1.5
- **Wrench size:** 24 mm
- **Dimension H:** 4 mm
- **Thread length L:** 8 mm

Art. No.: 3455.20.17

- **E-No.:** 126 341 571
- **Inner packaging:** ST
- **Outer packaging:** 100 ST
- **Individual net weight:** 2,720 G
- **EAN:** 7611614223599
- **ETIM40:** EC001469