

Synthetic reduction fittings

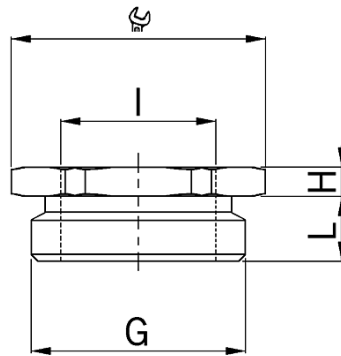

- **Material:** Polyamide PA 6
- **Properties:** halogen-free
- **minimal operation temperature:** -30°C
- **maximum operation temperature:** +100°C
- **Protection class:** IP 54
- **Further protection:** IP 68, if the entry thread is sealed

- hexagonal
- Outer thread metric
- Inner thread metric
- Light grey RAL 7035

- **Thread outside:** M63x1.5
- **Internal thread:** M32x1.5
- **Wrench size:** 68 mm
- **Dimension H:** 6 mm
- **Thread length L:** 12 mm

Art. No.: 3455.63.32

- **E-No.:** 126 341 981
- **Inner packaging:** ST
- **Outer packaging:** 5 ST
- **Individual net weight:** 26,400 G
- **EAN:** 7611614223766
- **ETIM40:** EC001469