

Adapter nickel-plated brass

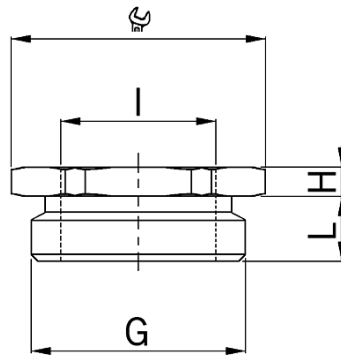

- **Material:** Nickel-plated brass
- **O-ring:** NBR
- **minimal operation temperature:** -40°C
- **maximum operation temperature:** +100°C
- **Protection class:** IP 68

- hexagonal
- Outer thread Pg
- Inner thread metric
- with O-ring

- **Thread outside:** Pg 13
- **Internal thread:** M12x1.5
- **Wrench size:** 24 mm
- **Dimension H:** 3.0 mm
- **Dimension L:** 6 mm
- 1 = Metric coarse-pitch thread

Art. No.: 3500.13.12

- **E-No.:** 126 350 312
- **Inner packaging:** ST
- **Outer packaging:** 50 ST
- **Individual net weight:** 19,300 G
- **Single volume:** 0,009 L
- **EAN:** 7611614121598
- **ETIM40:** EC001469