

## Adapter nickel-plated brass

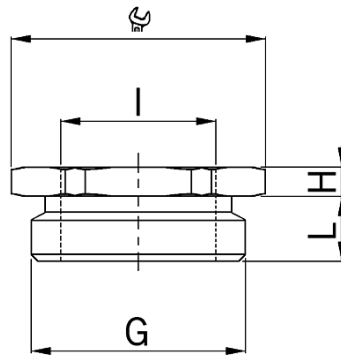

- **Material:** Nickel-plated brass
- **O-ring:** NBR
- **minimal operation temperature:** -40°C
- **maximum operation temperature:** +100°C
- **Protection class:** IP 68
  
- hexagonal
- Outer thread metric
- Inner thread Pg
- with O-ring
  
- **Thread outside:** M25x1.5
- **Internal thread:** Pg 11
- **Wrench size:** 30 mm
- **Dimension H:** 3.5 mm
- **Dimension L:** 7 mm

### **Art. No.:** 3500.25.11

- **E-No.:** 126 345 218
- **Inner packaging:** ST
- **Outer packaging:** 50 ST
- **Individual net weight:** 23,700 G
- **Single volume:** 0,018 L
- **EAN:** 7611614062631
- **ETIM40:** EC001469