

Adapter nickel-plated brass

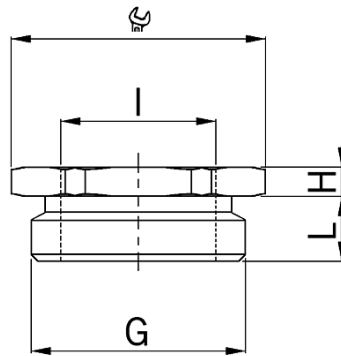

- **Material:** Nickel-plated brass
- **O-ring:** NBR
- **minimal operation temperature:** -40°C
- **maximum operation temperature:** +100°C
- **Protection class:** IP 68

- hexagonal
- Outer thread Pg
- Inner thread metric
- with O-ring

- **Thread outside:** Pg 48
- **Internal thread:** M50x1.5
- **Wrench size:** 65 mm
- **Dimension H:** 5.5 mm
- **Dimension L:** 11 mm
- 1 = Metric coarse-pitch thread

Art. No.: 3500.48.50

- **E-No.:** 126 350 850
- **Inner packaging:** ST
- **Outer packaging:** 5 ST
- **Individual net weight:** 139,800 G
- **Single volume:** 0,182 L
- **EAN:** 7611614121802
- **ETIM40:** EC001469