

## Reduction fittings nickel-plated brass

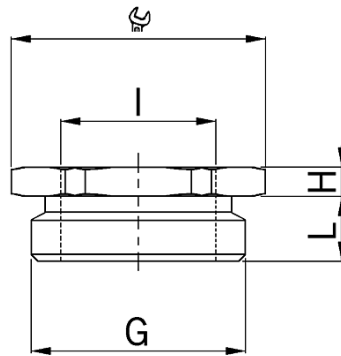

- **Material:** Nickel-plated brass
- **O-ring:** NBR
- **minimal operation temperature:** -40°C
- **maximum operation temperature:** +100°C
- **Protection class:** IP 68
  
- hexagonal
- Outer thread metric
- Inner thread metric
- with O-ring
  
- **Thread outside:** M63x1.5
- **Internal thread:** M50x1.5
- **Wrench size:** 70 mm
- **Dimension H:** 5.5 mm
- **Dimension L:** 10 mm
- 1 = Metric coarse-pitch thread

### **Art. No.:** 3500.63.50

- **E-No.:** 126 345 950
- **Inner packaging:** ST
- **Outer packaging:** 5 ST
- **Individual net weight:** 191,800 G
- **Single volume:** 0,182 L
- **EAN:** 7611614121444
- **ETIM40:** EC001469