

Reduction fittings nickel-plated brass

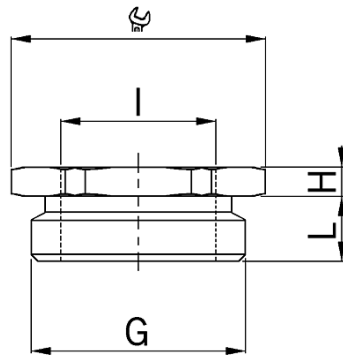

- **Material:** Nickel-plated brass
- **O-ring:** NBR
- **minimal operation temperature:** -40°C
- **maximum operation temperature:** +100°C
- **Protection class:** IP 68

- hexagonal
- Outer thread Pg
- Inner thread Pg
- with O-ring

- **Thread outside:** Pg 11
- **Internal thread:** Pg 7
- **Wrench size:** 20 mm
- **Dimension H:** 3.0 mm
- **Dimension L:** 6.5 mm

Art. No.: 3511.07

- **E-No.:** 126 345 020
- **Inner packaging:** ST
- **Outer packaging:** 50 ST
- **Individual net weight:** 11,700 G
- **Single volume:** 0,009 L
- **EAN:** 7611614038469
- **ETIM40:** EC001469