

## Reduction fittings nickel-plated brass

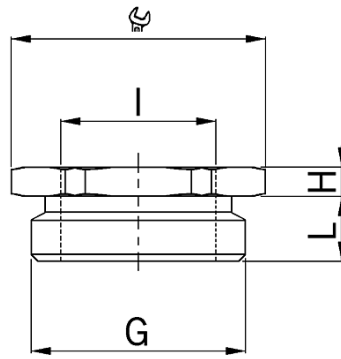

- **Material:** Nickel-plated brass
- **O-ring:** NBR
- **minimal operation temperature:** -40°C
- **maximum operation temperature:** +100°C
- **Protection class:** IP 68
  
- hexagonal
- Outer thread Pg
- Inner thread Pg
- with O-ring
  
- **Thread outside:** Pg 13
- **Internal thread:** Pg 11
- **Wrench size:** 24 mm
- **Dimension H:** 3.0 mm
- **Dimension L:** 7.0 mm

### **Art. No.:** 3513.11

- **E-No.:** 126 345 032
- **Inner packaging:** ST
- **Outer packaging:** 50 ST
- **Individual net weight:** 8,140 G
- **Single volume:** 0,009 L
- **EAN:** 7611614038551
- **ETIM40:** EC001469