

Reduction fittings nickel-plated brass

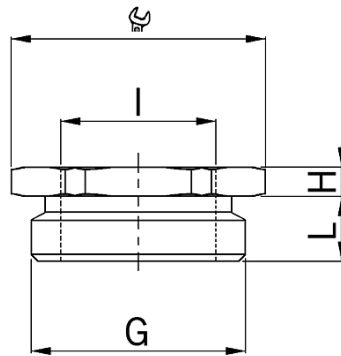

- **Material:** Nickel-plated brass
- **O-ring:** NBR
- **minimal operation temperature:** -40°C
- **maximum operation temperature:** +100°C
- **Protection class:** IP 68

- hexagonal
- Outer thread Pg
- Inner thread Pg
- with O-ring

- **Thread outside:** Pg 29
- **Internal thread:** Pg 13
- **Wrench size:** 38 mm
- **Dimension H:** 4.0 mm
- **Dimension L:** 8.0 mm

Art. No.: 3529.13

- **E-No.:** 126 345 063
- **Inner packaging:** ST
- **Outer packaging:** 10 ST
- **Individual net weight:** 77,100 G
- **Single volume:** 0,047 L
- **EAN:** 7611614038650
- **ETIM40:** EC001469