

Part number

CHI 24 LS



Bulkhead mounting housing, C-TYPE series, with 1 lever, size "104.27", with metal cover

Product description

Product type	Bulkhead mounting housing
Series	C-TYPE
Closing type	With 1 lever
Size	Size "104.27"
Specification	With metal cover

Technical data

IP degree of protection	IP65
--------------------------------	------

Further technical details

Weight	223,00 g
Operating temperature range (min, max)	-40°C...+125°C

Material properties

Colour	RAL 7040 grey
RoHs conformity	Compliant
China RoHs - EFUP	E
REACH SVHC substances	No

Approvals / Standards

Certifications	DNV-GL, BV
UL	ECBT2
cUL	ECBT8

General ordering information

EAN13 code	8015747018364
eCl@ss 8.1	27440202
ETIM 7.0	EC000437

Packaging Information

Packaging length	475,00 mm
Packaging height	220,00 mm
Packaging width	200,00 mm
Packaging weight	5,10 kg
Packaging volume	20,90 dm ³
Packaging description	Carton box
Packaging quantity	20 Pcs
Packaging EAN code	8015747018371
Sub-packaging weight	1,28 kg
Sub-packaging description	Plastic packaging
Sub-packaging quantity	5 Pcs
Sub-packaging EAN barcode	8015747018388

Part number

CHI 24 LS



Catalogue drawings

CHI L

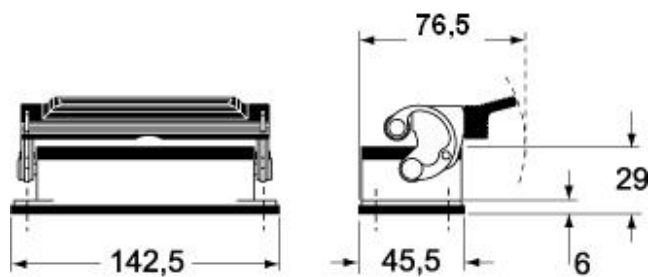

CHI LS

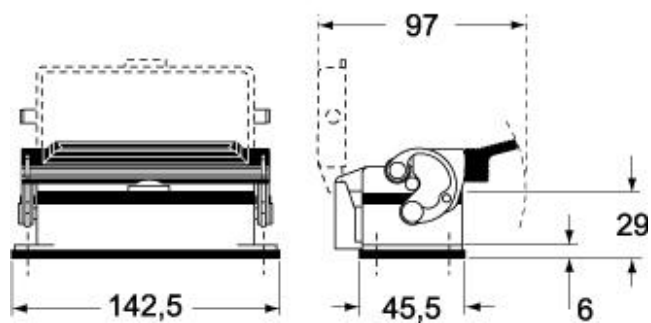

Catalogue drawings

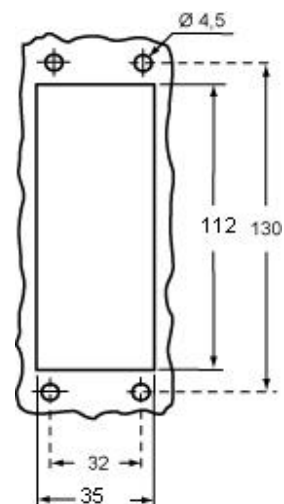

Notes

Dimensions shown in mm are not binding and may be changed without notice.