

Part number

CDSHM 18



Male insert, CDSH series, SQUICH® spring terminal connection without tools, 18 poles + PE, 10 A 400 V 6 kV 3, size "57.27"

Product description

Product type	Insert
Series	CDSH
Connection type	SQUICH® spring terminal connection without tools
Gender	Male
N. of poles	18 poles + 
Size	Size 57.27

Technical data

Current	10 A
Voltage	400 V
Rated impulse withstand voltage	6 kV
Pollution degree	3
Rated voltage according to UL/CSA	600 V
Wire cross-section	0,14 mm ² - 2,50 mm ²
AWG size	26 - 14
Contact type	Turned silver plated
IP degree of protection	IP20 without enclosure, IP65/IP66/IP68/IP69 with enclosure

Further technical details

Mating cycles	≥ 500
Insulation resistance	≥ 10 GΩ
Contact resistance	≤ 3 mΩ
Weight	69,50 g
Operating temperature range (min, max)	-40 °C ... +125 °C
UL 94 flammability rating	V-0

Material properties

Main material	Polycarbonate (PC)
Other materials	Contacts: copper alloy
Colour	RAL 7032 grey
RoHs conformity	Compliant with exemption 6(c): copper alloy containing up to 4% lead by weight
China RoHs - EFUP	50
REACH SVHC substances	Yes Lead
SCIP number	1a9c93ff-0445-4a16-81e3-1609ac5274d6

Approvals / Standards

Reference standard	EN 61984:2009-06
Certifications	DNV, BV, EAC, CQC
UL	ECBT2
cUL	ECBT8

General ordering information

EAN13 code	8015747222617
eCl@ss 8.1	27440205
ETIM 7.0	EC000438

Packaging Information

Packaging length	245,00 mm
Packaging height	165,00 mm
Packaging width	215,00 mm
Packaging weight	2,62 kg
Packaging volume	8,69 dm ³
Packaging description	Carton box
Packaging quantity	30 Pcs
Packaging EAN code	8015747222778
Sub-packaging length	197,00 mm
Sub-packaging height	55,00 mm
Sub-packaging width	113,00 mm
Sub-packaging weight	0,44 kg
Sub-packaging volume	1,22 dm ³
Sub-packaging description	Carton tray
Sub-packaging quantity	5 Pcs
Sub-packaging EAN barcode	8015747222785

Part number

CDSHM 18



Catalogue drawings

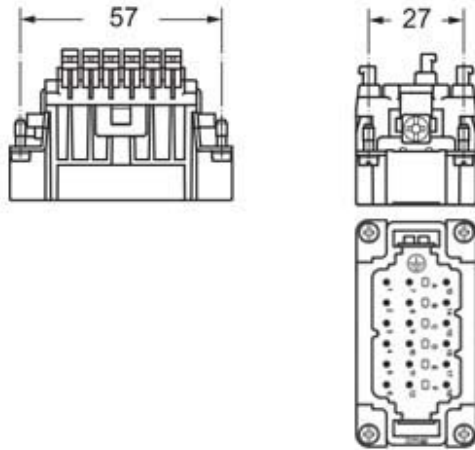

Derating curves

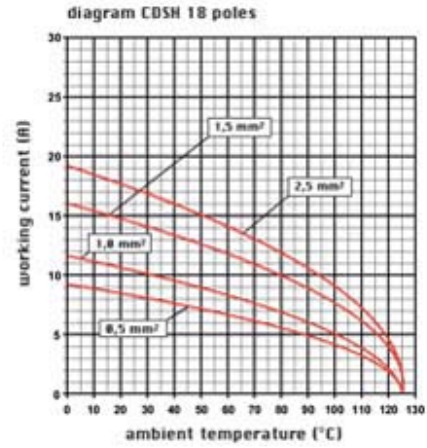

Notes

Dimensions shown in mm are not binding and may be changed without notice.

California Proposition 65 Information



WARNING

This product can expose you to lead and its compounds, known to the State of California to cause cancer and/or reproductive toxicity. For more information go to www.P65Warnings.ca.gov.

California Proposition 65 Information



WARNING

This product can expose you to lead and its compounds, known to the State of California to cause cancer and/or reproductive toxicity. For more information go to www.P65Warnings.ca.gov.

SQUICH® connection with actuator button

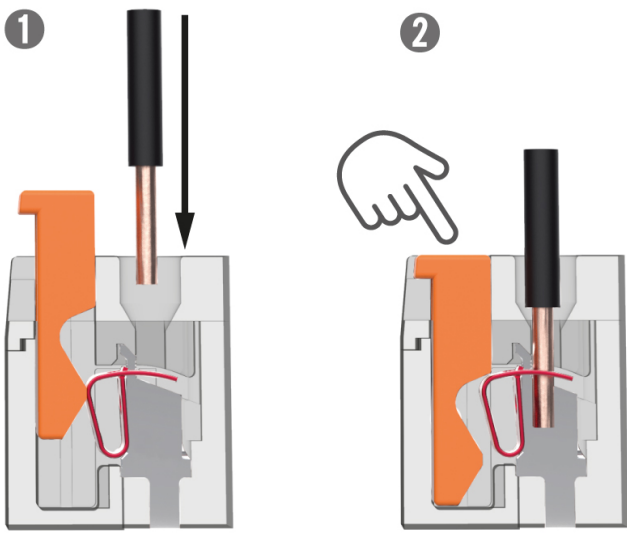

Reopening
