

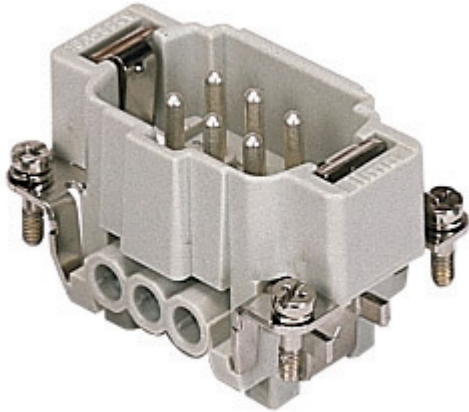

Part number

CNEM 06 T



Male insert, CNE series, screw terminal connection, 6 poles + PE, 16 A 500 V 6 kV 3, size "44.27", with plate

Product description

Product type	Insert
Series	CNE
Connection type	Screw terminal connection
Gender	Male
N. of poles	6 poles + 
Size	Size "44.27"
Specification	With plate

Technical data

Current	16 A
Voltage	500 V
Rated impulse withstand voltage	6 kV
Pollution degree	3
Rated voltage according to UL/CSA	600 V
Wire cross-section	0,50 mm ² - 4,00 mm ²
AWG size	20 - 12
Contact type	Turned silver plated
IP degree of protection	IP20 without enclosure, IP65/IP66/IP68/IP69 with enclosure

Further technical details

Characteristics according to EN 61984	16A 500V 6kV 3; 16A 400/690V 6kV 2
Mating cycles	≥ 500
Insulation resistance	≥ 10 GΩ
Contact resistance	≤ 1 mΩ
Weight	47,20 g
Operating temperature range (min, max)	-40 °C ... +125 °C
Conductors stripping length	7 mm
UL 94 flammability rating	V-0
Torque for main contact	M3: 0,5 Nm; 4,4 lb.in (Ph0 or 0,8 x 4 mm)

Material properties

Main material	Polycarbonate (PC)
Other materials	Contacts: copper alloy
Colour	RAL 7032 grey
RoHs conformity	Compliant with exemption 6(c): copper alloy containing up to 4% lead by weight
China RoHs - EFUP	50
REACH SVHC substances	Yes Lead

Approvals / Standards

Reference standard	EN 61984:2009-06
Certifications	CSA, CQC, DNV-GL, BV, EAC
UL	ECBT2, PVVA2
cUL	ECBT8, PVVA8

General ordering information

EAN13 code	8015747032797
eCl@ss 8.1	27440205
ETIM 7.0	EC000438

Packaging Information

Packaging length	270,00 mm
Packaging height	75,00 mm
Packaging width	180,00 mm
Packaging weight	3,17 kg
Packaging volume	3,65 dm ³
Packaging description	Carton box
Packaging quantity	60 Pcs
Packaging EAN code	8015747032803
Sub-packaging length	104,00 mm
Sub-packaging height	36,00 mm
Sub-packaging width	180,00 mm
Sub-packaging weight	0,53 kg
Sub-packaging volume	0,67 dm ³
Sub-packaging description	Carton tray
Sub-packaging quantity	10 Pcs
Sub-packaging EAN barcode	8015747032810

Part number

CNEM 06 T



Catalogue drawings

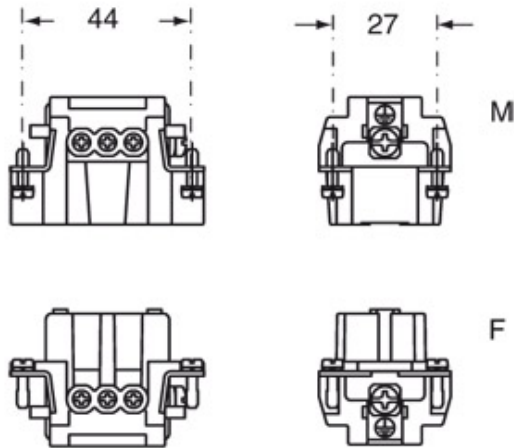

Catalogue drawings

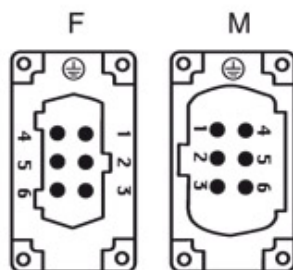
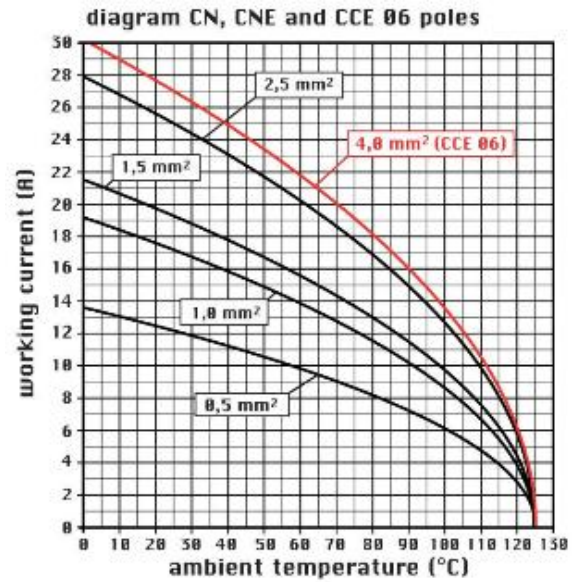

Notes

Dimensions shown in mm are not binding and may be changed without notice.

CNE ... : for non-prepared conductors



CNE ... X : for conductors with bush terminal

California Proposition 65 Information



WARNING

This product can expose you to lead and its compounds, known to the State of California to cause cancer and/or reproductive toxicity. For more information go to www.P65Warnings.ca.gov.
