

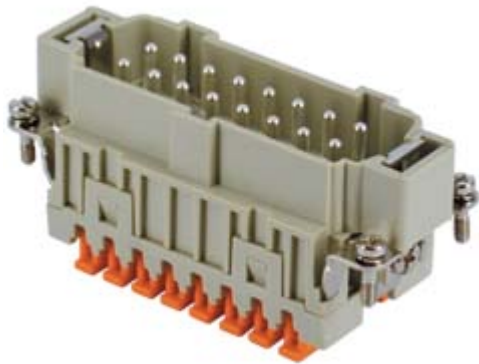

Part number

CSHM 16



Male insert, CSH series, SQUICH® spring terminal connection without tools, 16 poles + PE, 16 A 500 V 6 kV 3, size "77.27"

Product description	
Product type	Insert
Series	CSH
Connection type	SQUICH® spring terminal connection without tools
Gender	Male
N. of poles	16 poles + 
Size	Size "77.27"

Technical data	
Current	16 A
Voltage	500 V
Rated impulse withstand voltage	6 kV
Pollution degree	3
Rated voltage according to UL/CSA	600 V
Wire cross-section	0,14 mm ² - 2,50 mm ²
AWG size	26 - 14
Contact type	Turned silver plated
IP degree of protection	IP20 without enclosure, IP65/IP66/IP68/IP69 with enclosure

Further technical details	
Characteristics according to EN 61984	16A 500V 6kV 3; 16A 400/690V 6kV 2
Mating cycles	≥ 500
Insulation resistance	≥ 10 GΩ
Contact resistance	≤ 3 mΩ
Weight	85,50 g
Operating temperature range (min, max)	-40 °C ... +125 °C
Conductors stripping length	9...11 mm
UL 94 flammability rating	V-0

Material properties	
Main material	Polycarbonate (PC)
Other materials	Contacts: copper alloy
Colour	RAL 7032 grey
RoHs conformity	Compliant with exemption 6(c): copper alloy containing up to 4% lead by weight
China RoHs - EFUP	50
REACH SVHC substances	Yes Lead

Approvals / Standards	
Reference standard	EN 61984:2009-06
Certifications	CSA, CQC, DNV-GL, BV, EAC
UL	ECBT2, PVVA2
cUL	ECBT8, PVVA8

General ordering information	
EAN13 code	8015747110150
eCl@ss 8.1	27440205
ETIM 7.0	EC000438

Packaging Information	
Packaging length	245,00 mm
Packaging height	165,00 mm
Packaging width	215,00 mm
Packaging weight	3,06 kg
Packaging volume	8,69 dm ³
Packaging description	Carton box
Packaging quantity	30 Pcs
Packaging EAN code	8015747170765
Sub-packaging length	197,00 mm
Sub-packaging height	44,00 mm
Sub-packaging width	113,00 mm
Sub-packaging weight	0,51 kg
Sub-packaging volume	0,98 dm ³
Sub-packaging description	Carton tray
Sub-packaging quantity	5 Pcs
Sub-packaging EAN barcode	8015747170772

Part number

CSHM 16



Catalogue drawings

Catalogue drawings

dimensions in mm

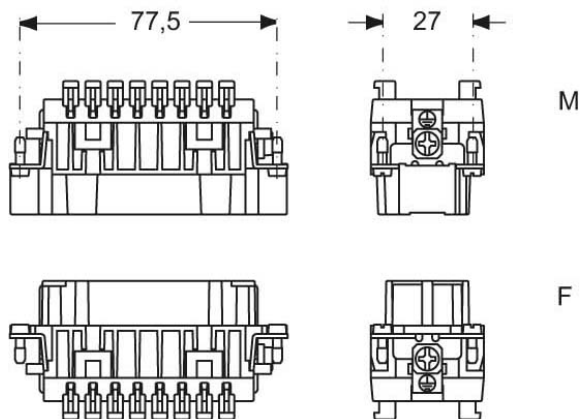

contacts side (front view)

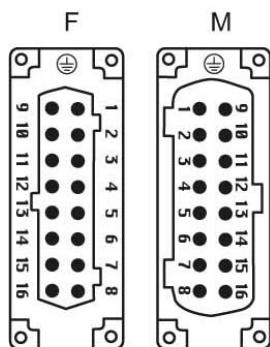
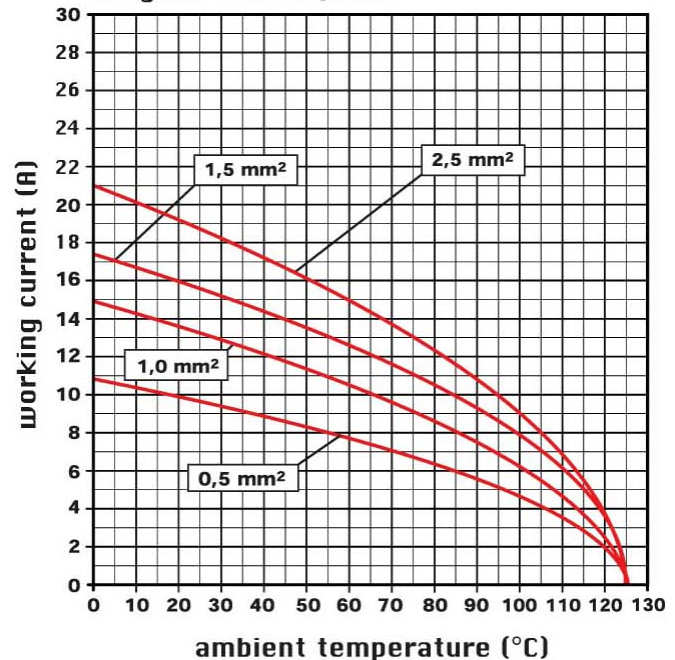

diagram CSH 16 poles



Notes

CSHF/M 16

- characteristics according to EN 61984:

16A 500V 6kV 3

16A 400/690V 6kV 2

- rated voltage according to UL/CSA: 600V

- insulation resistance: > 10 GOhm

- ambient temperature limit: -40 °C ... +125 °C

- are made of self-extinguishing thermoplastic resin UL 94 V0

- mechanical life: > 500 cycles

- contact resistance: < 3 mOhm

- enclosures: size "77.27":

C-TYPE IP65/IP66

C7 IP67 stainless steel lever

V-TYPE IP65/IP66

stainless steel lever

T-TYPE IP65 insulating

JEI zinc-plated steel lever

BIG hoods

W-TYPE aggressive environments

EMC

central lever

IP68

- panel supports:

COB

Dimensions shown in mm are not binding and may be changed without notice.

California Proposition 65 Information



WARNING

This product can expose you to lead and its compounds, known to the State of California to cause cancer and/or reproductive toxicity. For more information go to www.P65Warnings.ca.gov.

SQUICH® connection with actuator button

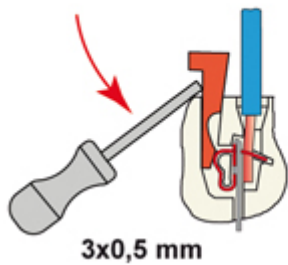
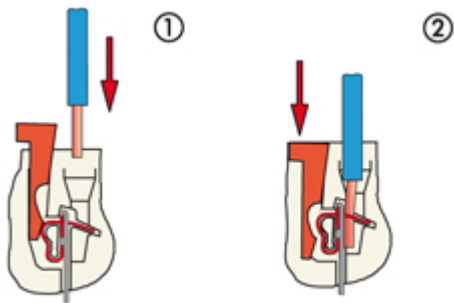

Reopening