

Part number

CX 02 4BF



Female modular insert, Mixo series, screw terminal connection, 2 poles, 1 module, 40 A 1000 V 8 kV 3

| Product description | | Material properties | |
|---|--|----------------------------------|--|
| Product type | Modular insert | Main material | Polycarbonate |
| Series | Mixo | Colour | RAL 7032 grey |
| Connection type | Screw terminal connection | | Compliant with exemption 6(c): copper alloy containing up to 4% lead by weight |
| Gender | Female | RoHs conformity | |
| N. of poles | 2 poles | China RoHs - EFUP | 50 |
| Size | 1 module | REACH SVHC substances | Yes Lead |
| Technical data | | SCIP number | 1a9c93ff-0445-4a16-81e3-1609ac5274d6 |
| Current | 40 A | Approvals / Standards | |
| Voltage | 1000 V | Reference standard | EN 61984:2009-06 |
| Rated impulse withstand voltage | 8 kV | Certifications | CSA, CQC, DNV, BV, EAC |
| Pollution degree | 3 | UL | ECBT2 |
| Rated voltage according to UL/CSA | 600 V | cUL | ECBT8 |
| Wire cross-section | 6,00 mm ² - 10,00 mm ² | General ordering information | |
| AWG size | 10 - 8 | EAN13 code | 8015747048170 |
| Contact type | Turned silver plated | eCl@ss 8.1 | 27440205 |
| IP degree of protection | IP20 without enclosure, IP65/IP66/IP68/IP69 with enclosure | ETIM 7.0 | EC000438 |
| Further technical details | | Packaging Information | |
| Characteristics according to EN 61984 | 40A 1000V 8kV 3 | Packaging length | 180,00 mm |
| Insulation resistance | ≥ 10 GΩ | Packaging height | 120,00 mm |
| Contact resistance | ≤ 0,5 mΩ | Packaging width | 155,00 mm |
| Weight | 23,00 g | Packaging weight | 1,51 kg |
| Operating temperature range (min, max) | -40 °C ... +125 °C | Packaging volume | 3,35 dm ³ |
| UL 94 flammability rating | V-0 | Packaging description | Carton box |
| | | Packaging quantity | 60 Pcs |
| | | Packaging EAN code | 8015747221122 |
| | | Sub-packaging length | 35,00 mm |
| | | Sub-packaging height | 40,00 mm |
| | | Sub-packaging width | 155,00 mm |
| | | Sub-packaging weight | 0,25 kg |
| | | Sub-packaging volume | 0,22 dm ³ |
| | | Sub-packaging description | Carton tray |
| | | Sub-packaging quantity | 10 Pcs |
| | | Sub-packaging EAN barcode | 8015747143677 |

Part number

CX 02 4BF



Catalogue drawings

Catalogue drawings

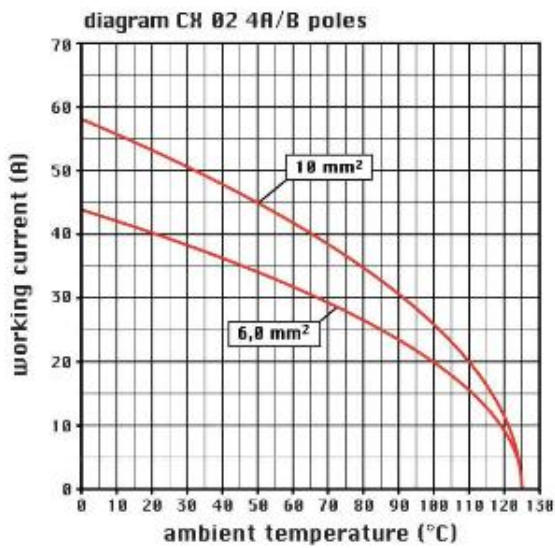

CX 02 4BM

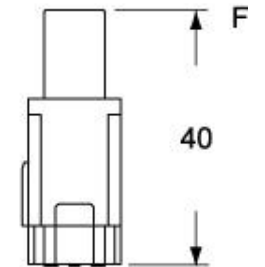
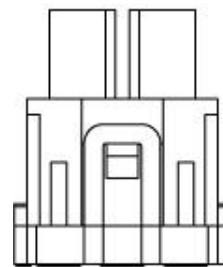
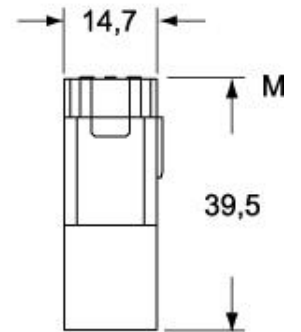
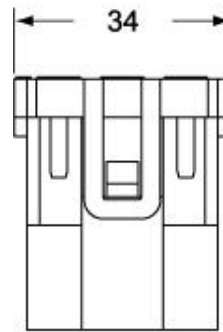

CX 02 4BF

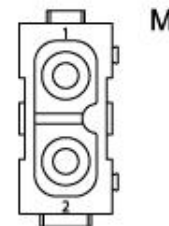
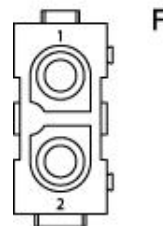

Notes

Standard modular inserts:
-in combination with standard contacts and standard frames (CX ... TF/TM); must be mounted either in traditional enclosures or in COB panel supports (both up to 500 matings).

Dimensions shown in mm are not binding and may be changed without notice.

California Proposition 65 Information



WARNING

This product can expose you to lead and its compounds, known to the State of California to cause cancer and/or reproductive toxicity. For more information go to www.P65Warnings.ca.gov.
