

Part number

CX 06 CYF



Female modular insert, Mixo series, AXYR® spring push-in terminal connection without tools, 6 poles, 1 module, 16 A 500 V 6 kV 3

Product description		Material properties	
Product type	Modular insert	Main material	Polycarbonate (PC)
Series	Mixo	Other materials	Contacts: copper alloy
Connection type	AXYR® high density spring terminal connection without tools	Colour	RAL 7032 grey
Gender	Female	RoHs conformity	Compliant with exemption 6(c): copper alloy containing up to 4% lead by weight
N. of poles	6 poles	China RoHs - EFUP	50
Size	1 module	REACH SVHC substances	Yes Lead
Technical data		General ordering information	
Current	16 A	EAN13 code	8015747016483
Voltage	500 V	eCl@ss 8.1	27440205
Rated impulse withstand voltage	6 kV	ETIM 7.0	EC000438
Pollution degree	3	Packaging Information	
Rated voltage according to UL/CSA	600 V	Packaging length	220,00 mm
Wire cross-section	0,25 mm ² - 4,00 mm ²	Packaging height	130,00 mm
AWG size	24 - 12	Packaging width	240,00 mm
Contact type	Turned silver plated	Packaging weight	1,50 kg
IP degree of protection	IP20 without enclosure, IP65/IP66/IP68/IP69 with enclosure	Packaging volume	6,86 dm ³
Further technical details		Packaging description	Carton box
Characteristics according to EN 61984	16 A 500 V 6 kV 3	Packaging quantity	60 Pcs
Mating cycles	≥ 500	Packaging EAN code	8015747127578
Insulation resistance	≥ 10 GΩ	Sub-packaging weight	0,03 kg
Contact resistance	≤ 3 mΩ	Sub-packaging description	Plastic bag
Weight	20,50 g	Sub-packaging quantity	1 Pcs
Operating temperature range (min, max)	-40 °C ... +125 °C	Sub-packaging EAN barcode	8015747139854
Conductors stripping length	9...11 mm		
UL 94 flammability rating	V-0		

Part number

CX 06 CYF



Catalogue drawings

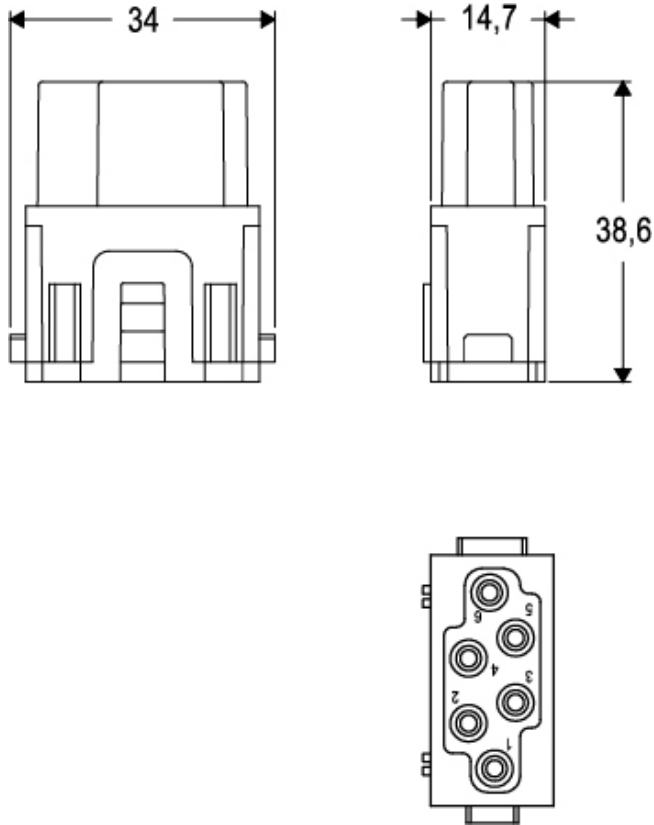

Derating curves

CX..CY 6 poles connector inserts
Maximum current load derating diagram

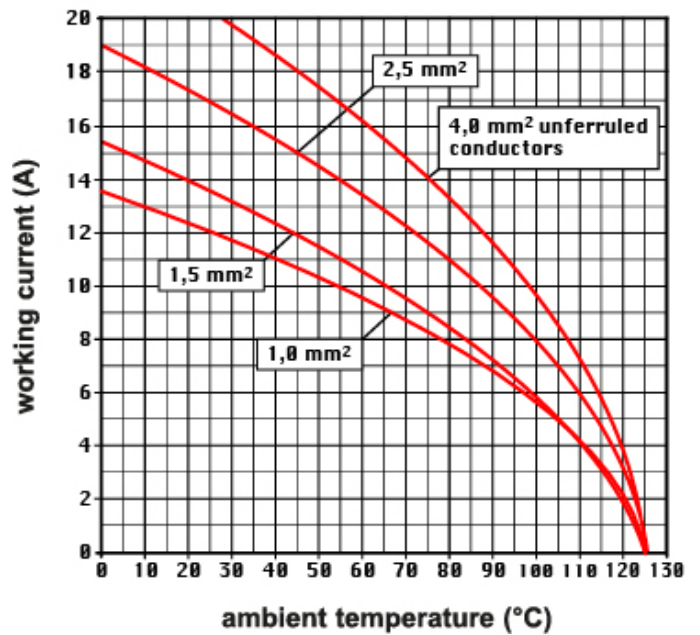

Notes

Standard modular inserts:
-in combination with standard contacts and standard frames (CX ... TF/TM); must be mounted either in traditional enclosures or in COB panel supports (both up to 500 matings).

0,14 - 1,5 mm² (26 - 16 AWG)

Dimensions shown in mm are not binding and may be changed without notice.

AXYR® Mixo series inserts for wires with the following cross-sectional areas either ferruled or unferruled:

- modules from 6 to 8 poles
0,25 - 4 mm² (24 - 12 AWG)
for prepared wires useable section:
0,25 - 2,5 mm² (24 - 14 AWG)

-12 poles modules
0,14 - 2,5 mm² (26 - 14 AWG)
for prepared wires useable section: