

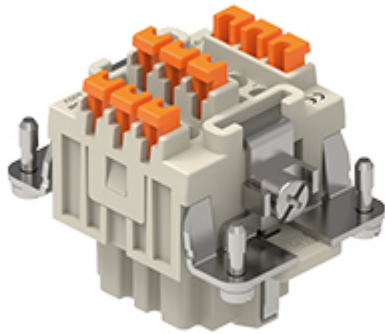

Part number

RDSHF 09



Female insert, RDSH series, SQUICH® spring terminal connection without tools, 9 poles + PE, 10 A 400 V 6 kV 3, size "44.27", HNM - High Number of Matings version

Product description

Product type	Insert
Series	RDSH
Connection type	SQUICH® spring terminal connection without tools
Gender	Female
N. of poles	9 poles + 
Size	Size 44.27
Specification	HNM - High Number of Matings version

Technical data

Current	10 A
Voltage	400 V
Rated impulse withstand voltage	6 kV
Pollution degree	3
Rated voltage according to UL/CSA	600 V
Wire cross-section	0,14 mm ² - 2,50 mm ²
AWG size	26 - 14
Contact type	Turned gold plated
IP degree of protection	IP20 without enclosure, IP65/IP66/IP68/IP69 with enclosure

Further technical details

Characteristics according to EN 61984	10A 400V 6kV 3; 10A 400/690V 6kV 2
Mating cycles	≥ 10000
Insulation resistance	≥ 10 GΩ
Contact resistance	≤ 3 mΩ
Weight	52,50 g
Operating temperature range (min, max)	-40°C...+125°C
Conductors stripping length	9...11 mm
UL 94 flammability rating	V-0

Material properties

Main material	Polycarbonate (PC)
Other materials	Contacts: copper alloy
Colour	RAL 7032 grey
RoHs conformity	Compliant with exemption 6(c); copper alloy containing up to 4% lead by weight
China RoHs - EFUP	50
REACH SVHC substances	Yes Lead
SCIP number	1a9c93ff-0445-4a16-81e3-1609ac5274d6

Approvals / Standards

Certifications	DNV, EAC
-----------------------	----------

General ordering information

EAN13 code	8015747113328
eCl@ss 8.1	27440205
ETIM 7.0	EC000438

Packaging Information

Packaging length	245,00 mm
Packaging height	165,00 mm
Packaging width	215,00 mm
Packaging weight	3,63 kg
Packaging volume	8,69 dm ³
Packaging description	Carton box
Packaging quantity	60 Pcs
Packaging EAN code	8015747113335
Sub-packaging length	197,00 mm
Sub-packaging height	55,00 mm
Sub-packaging width	113,00 mm
Sub-packaging weight	0,61 kg
Sub-packaging volume	1,22 dm ³
Sub-packaging description	Carton tray
Sub-packaging quantity	10 Pcs
Sub-packaging EAN barcode	8015747113366

Part number

RDSHF 09



Catalogue drawings

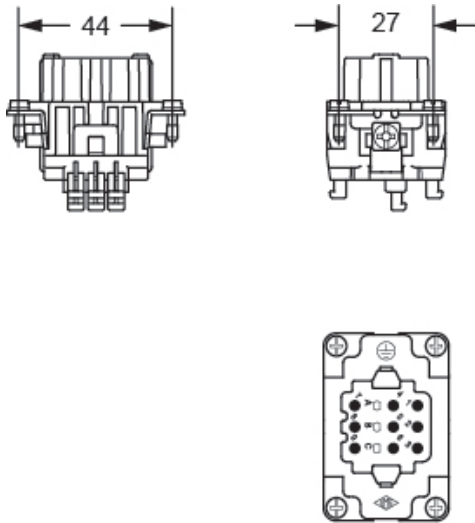

Derating curves

RDSH 09 poles connector inserts
Maximum current load derating diagram

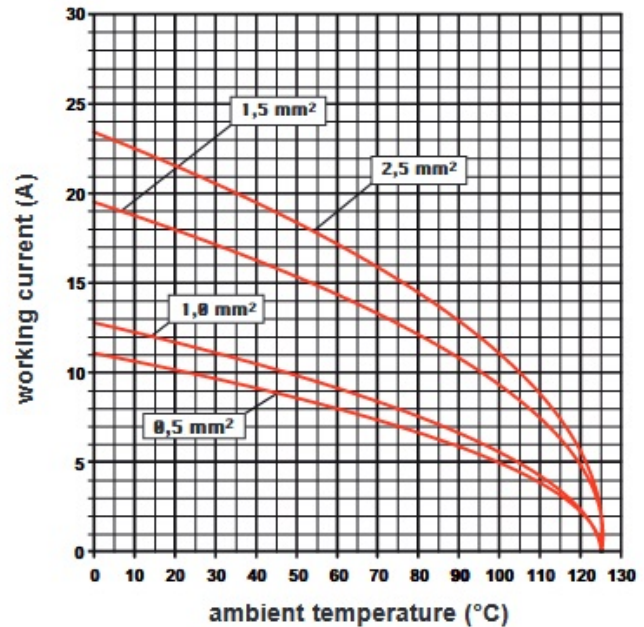

Notes

California Proposition 65 Information



WARNING

This product can expose you to lead and its compounds, known to the State of California to cause cancer and/or reproductive toxicity. For more information go to www.P65Warnings.ca.gov.

California Proposition 65 Information



WARNING

This product can expose you to lead and its compounds, known to the State of California to cause cancer and/or reproductive toxicity. For more information go to www.P65Warnings.ca.gov.

Dimensions shown in mm are not binding and may be changed without notice.

SQUICH® connection with actuator button



Reopening
