

Diritti riservati All rights reserved

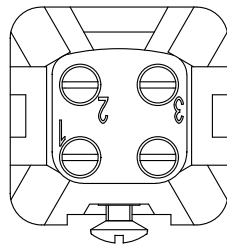
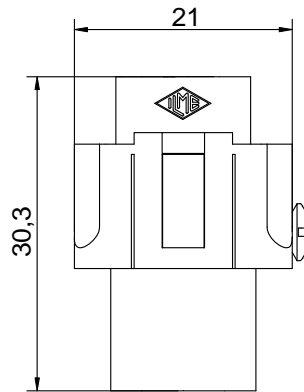
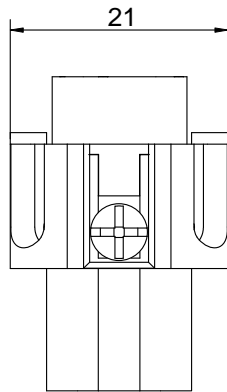
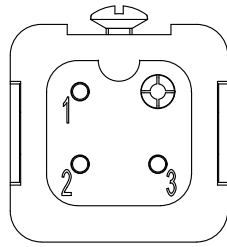

Date 25.10.2006

Sign.

CKF 03

female insert, screw, 03P 10A 250V

Scale

2:1

