

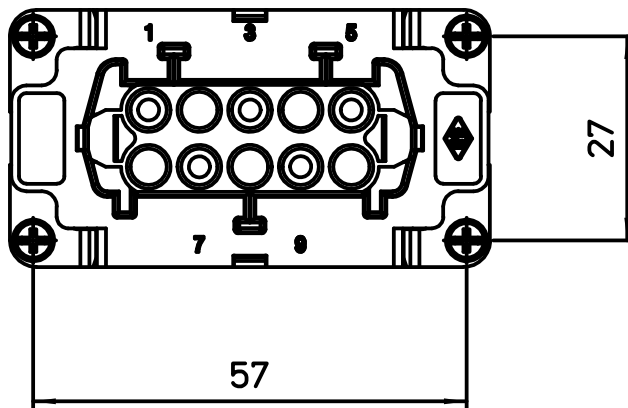

Diritti riservati All rights reserved

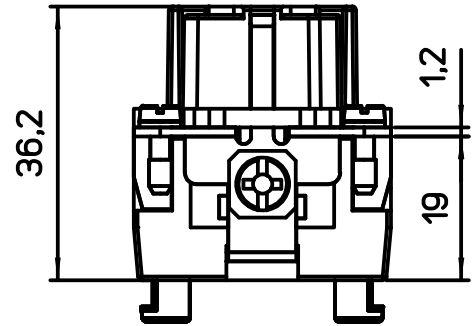
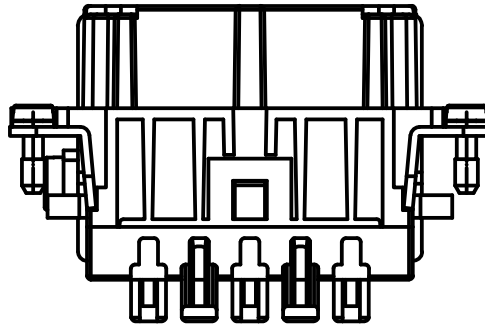
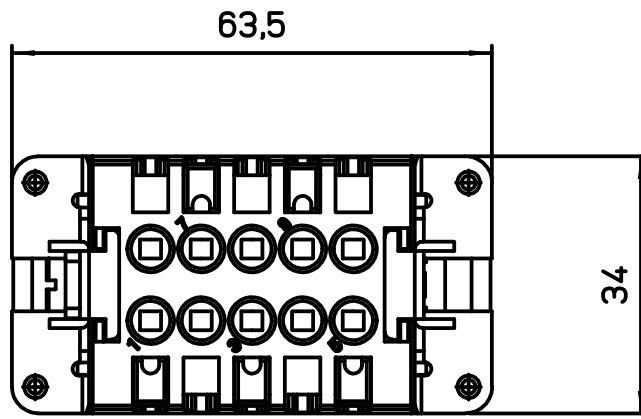

dimensions in mm	CMSHF 03 SQUICH female insert, spring, 3P 16A 830V	Scale	
Date 03/08/15		1:1	
Sign. M.Pezzimenti			