

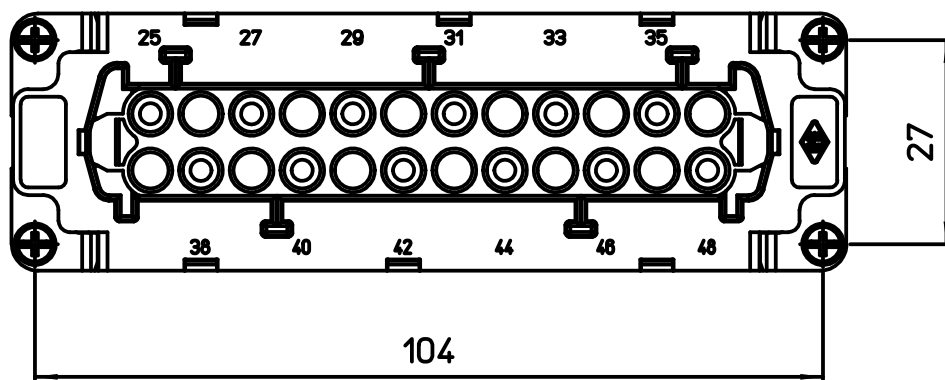

Diritti riservati All rights reserved

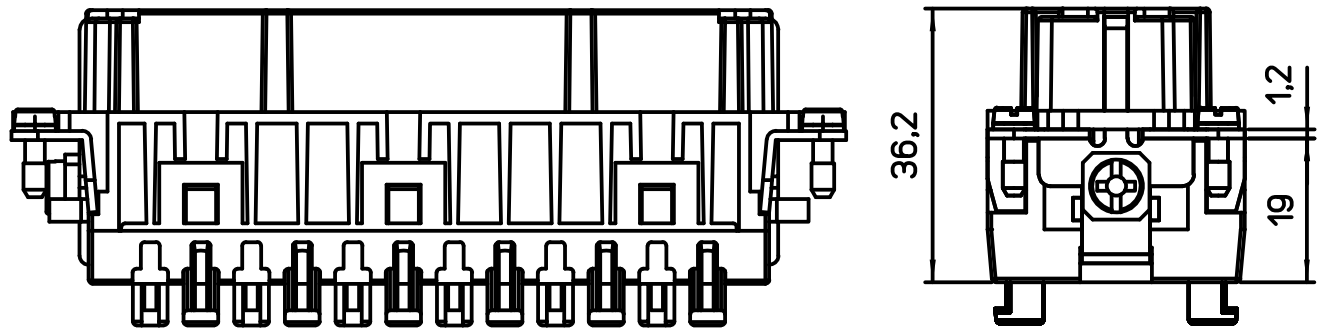
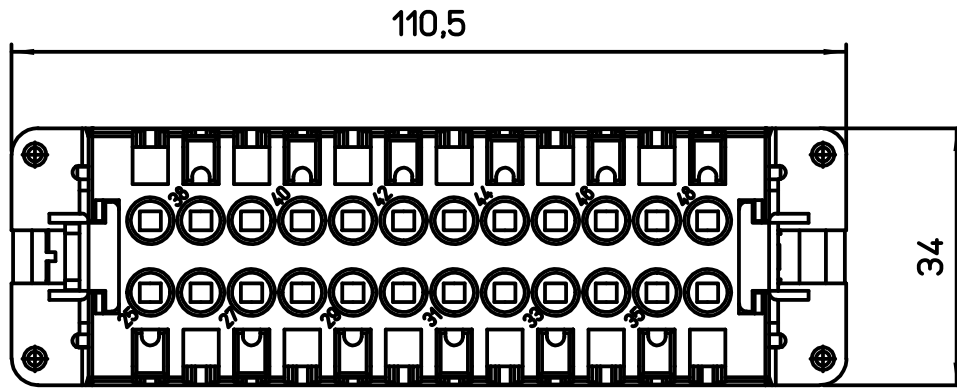

dimensions in mm	CMSHF 10 N SQUICH female insert, spring, 10P 16A 830V	Scale	
Date 07/06/16		1:1	
Sign. D. Bonino			