

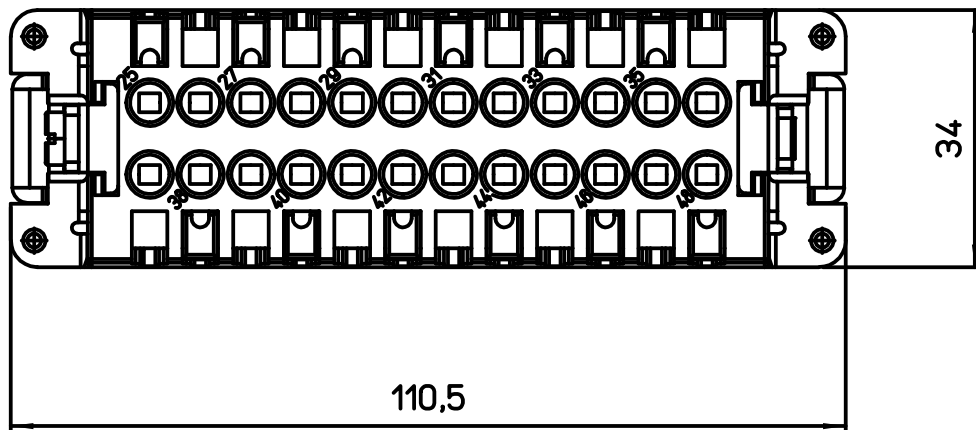

Diritti riservati All rights reserved

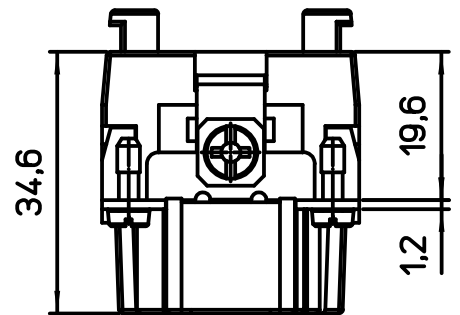
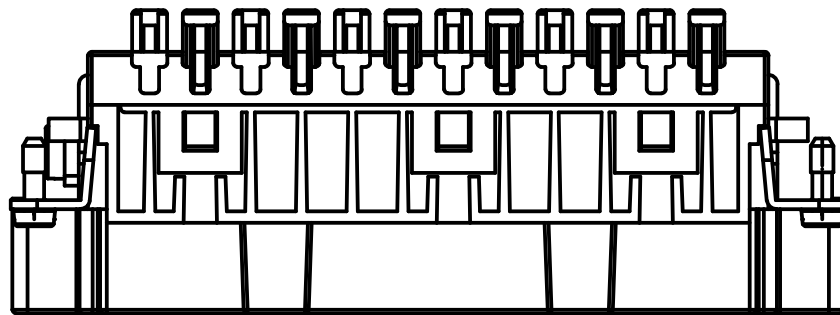
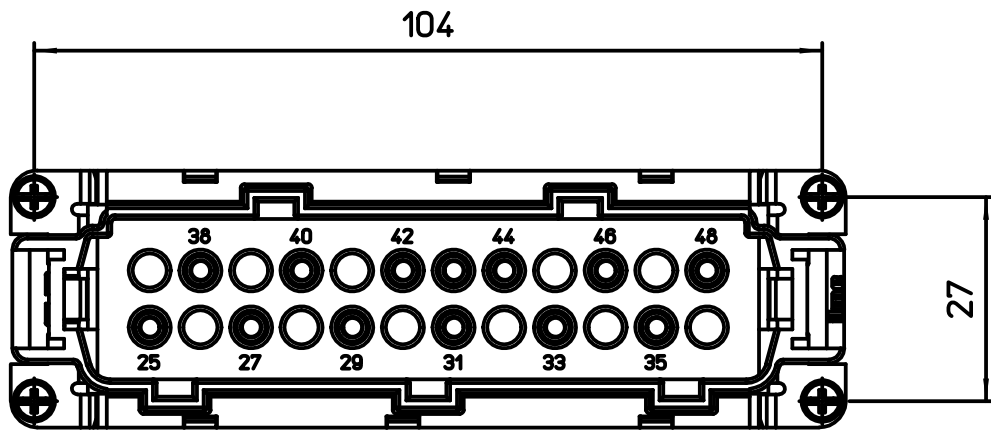

dimensions in mm	CMSHM 10 N SQUICH female insert, spring, 10P 16A 830V	Scale	
Date 07/06/16		1:1	
Sign. D. Bonino			