

Diritti riservati All rights reserved

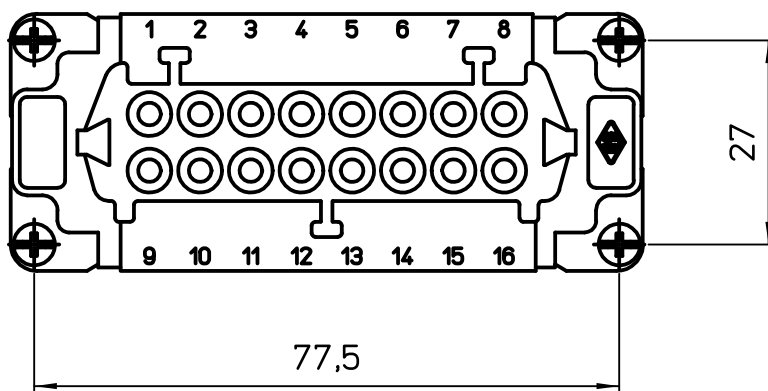
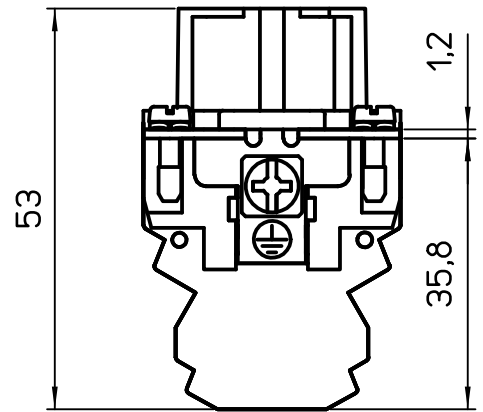
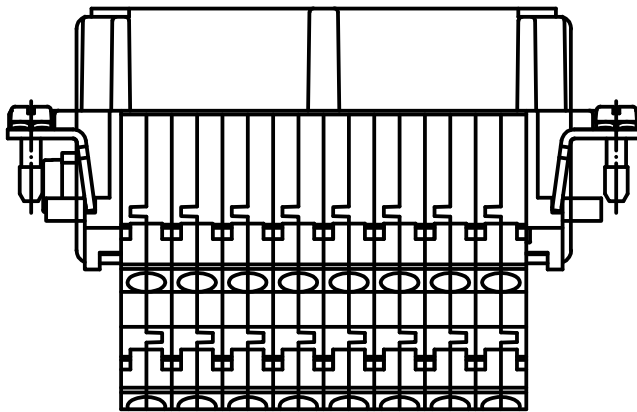
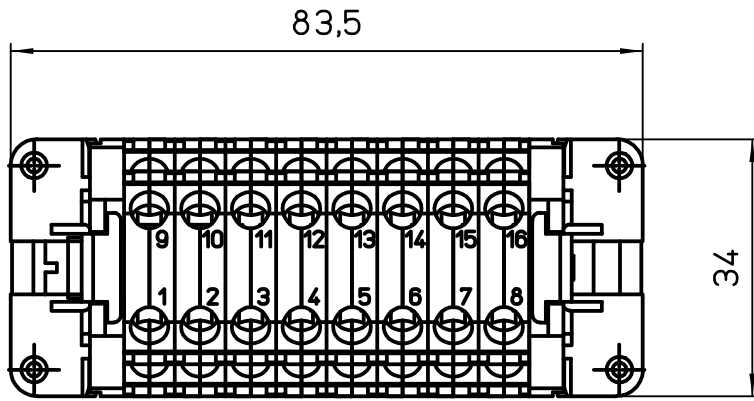

Date 03/03/08

Sign. T.Tedeschi

CSSF 16

female insert, double spring, 16P 16A 500V

Scale

1:1

