

1

2

3

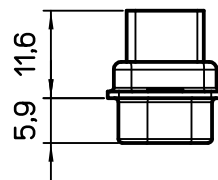
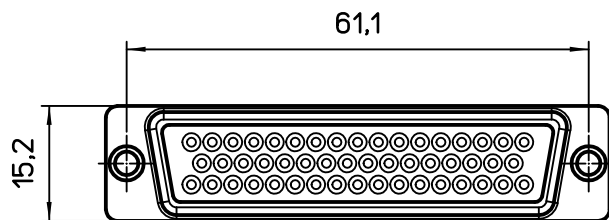
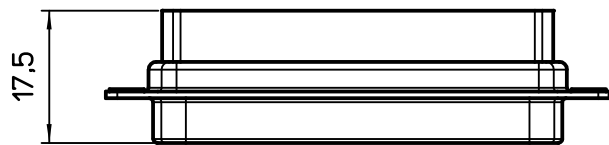
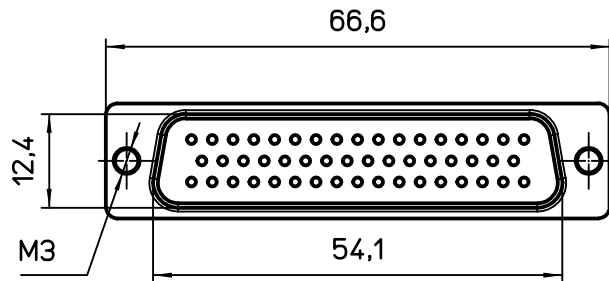

Rear mounting panel cut-out

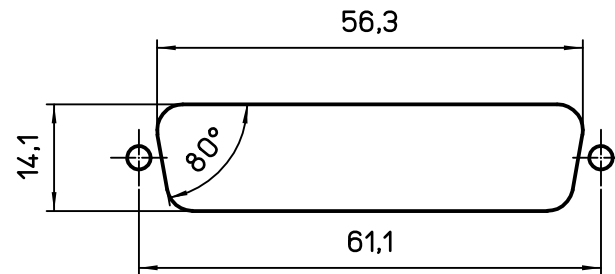

Front mounting panel cut-out

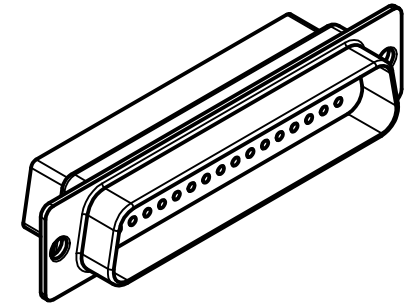
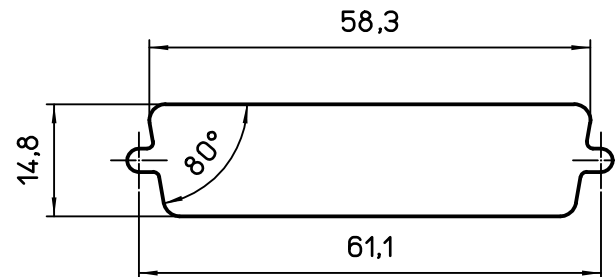

REV.	DATE	SIGNATURE		
Dimensions in mm		Simplified representation with dimensions without tolerance		
Original Size A4		DTPCM 50		Scale 1:1
Date 22/02/22		D-Sub male connectors, 50P		
Sign. S. Diasparra				

1

2

3