

Diritti riservati All rights reserved

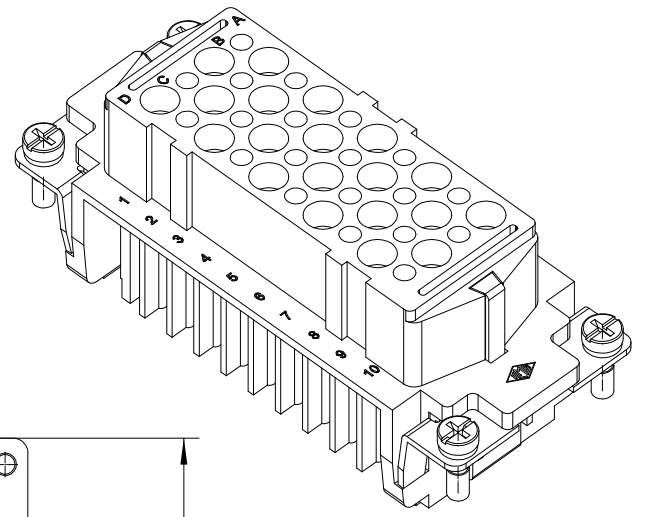
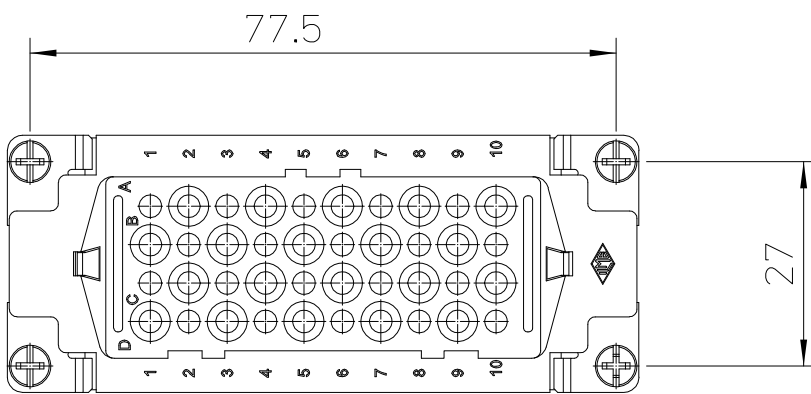
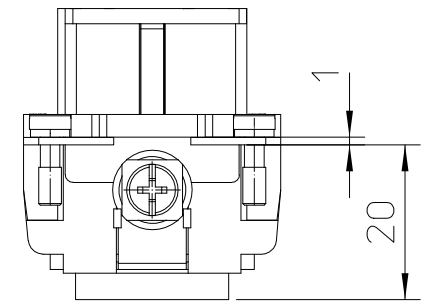
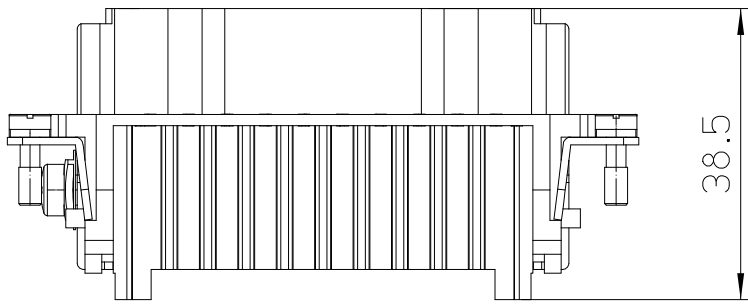
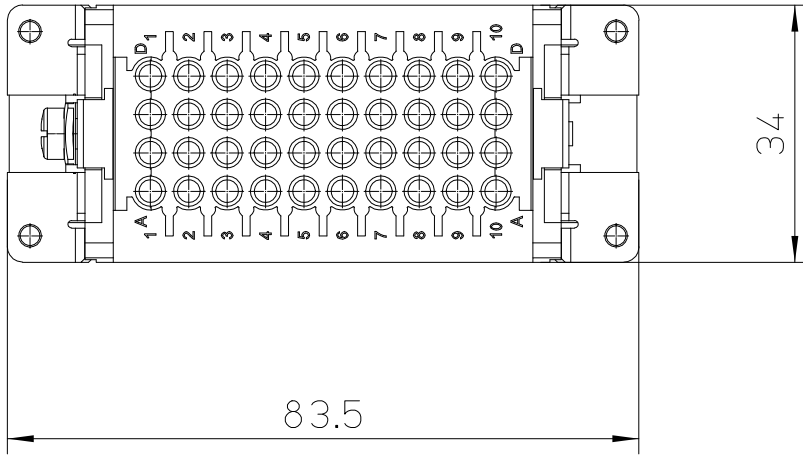

dimensions in mm
Date 04/01/17
Sign. C. Mainini

RDF 40
Female insert, crimp, 40P 10A 250V - High Number Cycles

Scale
1:1

