

A

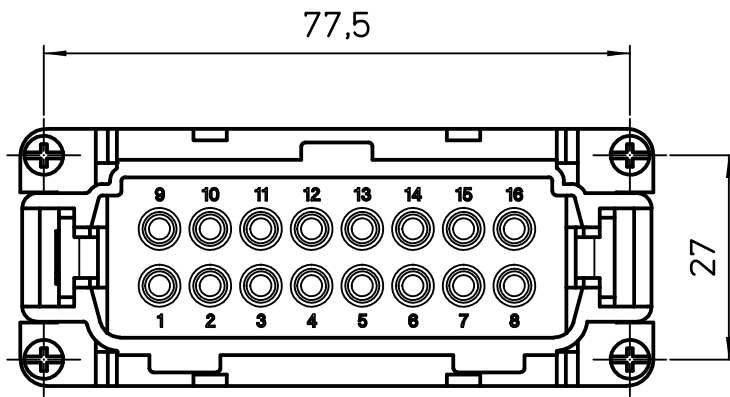

A

Diritti riservati All rights reserved

B

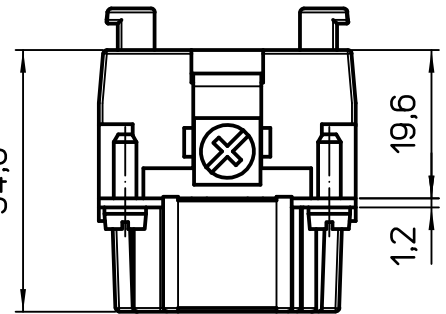
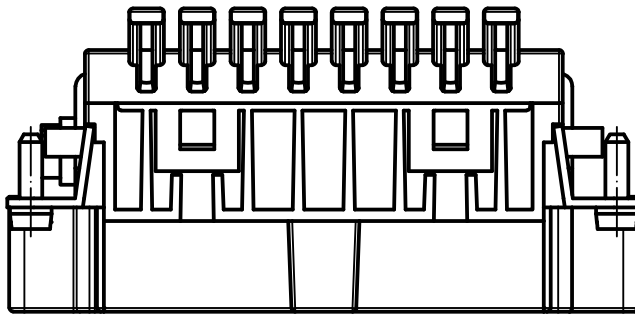

B

C

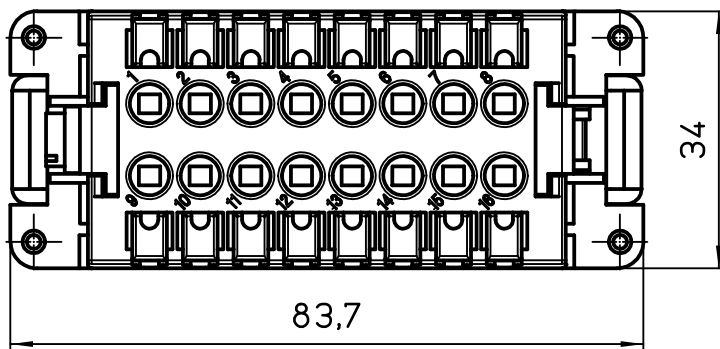

C

REV.	DATE	SIGNATURE



Dimensions in mm

Simplified representation with dimensions without tolerance

Original Size A4

Date 28/04/21

Sign. S. Diasparra

RSHM 16
 SQUICH male insert, spring, 16P 16A 500V - HNM

Scale
 1:1

