

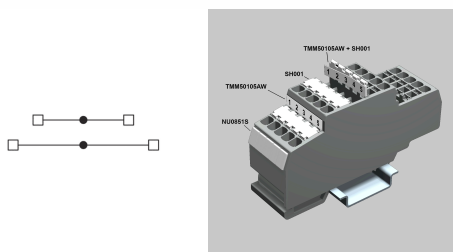

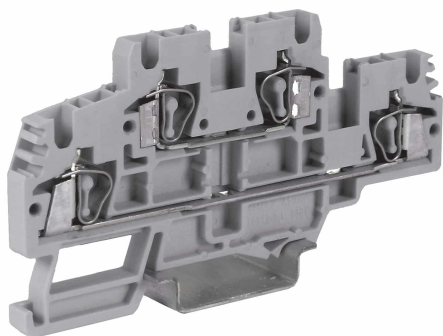



spring clamp terminal block 2 levels feed-through, 2.5 mm<sup>2</sup>, grey



<b>Series</b>	HMD
<b>Code</b>	HD100GR
<b>Type</b>	HMD.2/GR
<b>HS code</b>	85369010
<b>Colour</b>	grey
<b>TECHNICAL FEATURES</b>	
<b>Function/Type</b>	2 levels feed-through
<b>Rated cross-section</b>	2.5 mm <sup>2</sup>
<b>Connecting capacity</b>	
<b>Flexible wire</b>	0.2-4 mm <sup>2</sup>
<b>Rigid wire</b>	0.2-4 mm <sup>2</sup>
<b>Wire with ferrule - ferrule type</b>	1.5 mm <sup>2</sup> - WP15/14
<b>Electrical characteristics according to IEC EN standard</b>	
<b>Maximum voltage AC/DC</b>	630 V
<b>Maximum current (rated cross-section)</b>	24 A
<b>Caliber</b>	A3
<b>Electrical characteristics according to UL Standard</b>	
<b>Maximum voltage AC/DC</b>	300 V
<b>Maximum current (rated cross-section)</b>	20 A
<b>Section (min-max)</b>	24-12 (AWG)
<b>Electrical characteristics according to ATEX directive and IEC Ex standard</b>	
<b>Maximum voltage AC/DC</b>	400 V
<b>Maximum current (rated cross-section)</b>	24 A
<b>Operating temperature Min/Max</b>	-40 °C / +80 °C
<b>Rated impulse withstand voltage / pollution degree</b>	8 kV / 3
<b>Insulation stripping length</b>	10 mm
<b>Width (pitch)</b>	5.2 mm
<b>Length</b>	91 mm
<b>Height mounted on TH35-7.5/TH35-15/G32</b>	49 / 56 / - mm
<b>Insulation material temperature index (EN 60216-1)</b>	130 °C
<b>Plastic material</b>	Polyamide UL94V-0
<b>ACCESSORIES</b>	
<b>End section</b>	
<b>Grey</b>	HMD/PT/GR (cod. HD101GR)
<b>Blue</b>	-
<b>Thickness</b>	1.5 mm
<b>Cross-connection</b>	
<b>Model A)</b>	PH/2.5-4 (cod. PH100)
<b>Model B)</b>	PHD/2 (cod. PHD02)
<b>Rated current carrying capacity IEC/ATEX</b>	24 A / 24 A
<b>Cross-connection identification strip</b>	-
<b>Internal removable cross-connection</b>	PHD/2 (cod. PHD02)
<b>Coloured partition plate</b>	DFH/4/R (cod. DH04R)
<b>Cross-connection barrier</b>	-
<b>Test plug</b>	-
<b>Modular test plug</b>	-
<b>End section for modular test plug</b>	-
<b>Marking</b>	
<b>Single marking tag</b>	CNU/8/51 (cod. NU0851S) (only on lower level)
<b>Single marking tag for pitch insertion</b>	CNU/8/51 (cod. NU0851S) (only on lower level), SHZ/2 (cod. SH001) + TMM50105AW (cod. TMM50105AW)
<b>End bracket</b>	
<b>TH35 screw type</b>	BT/3 (cod. BT003)
<b>TH35 snap-fit type</b>	BTO (cod. BT007)
<b>TH35 and G32 snap-fit type</b>	BTU (cod. BT005)
<b>DIN rail according to IEC 60715/TH35</b>	PR/3/..
<b>APPROVALS AND MARKINGS</b>	    

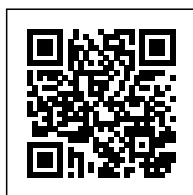

1 For more details on accessories, refer to the relevant chapters

## DESCRIZIONE DEL PRODOTTO

spring clamp terminal block 2 levels feed-through, 2.5 mm<sup>2</sup>, grey