

EURO PRO 95

Article: **606095**

Universal terminal blocks for **Cu/Al** conductors
 Feed-through terminal block – grey
 Screw connection system - 1xAl/Cu 6/95mm²
 The conductive parts are made of tin-plated aluminium.



GENERAL INFORMATION

Series	EURO PRO
Item	606095
Weight/Piece	65 g
Customs tariff	85369010
Page/Catalog	- / -
Colour	Grey
Q.ty p.pck.	20
Q.ty p. box	-

TECHNICAL DATA / DIMENSIONS

Dimensions

Width mm(in.)	25 (0.99)
Length mm(in.)	84 (3.31)
Length (L1) mm(in.)	72 (2.84)
Height mm(in.)	51 (2.01)
Height (H1) mm(in.)	5 (1.97)
Mounting type	Omega TH35

Technical data

Protection degree (IP)	IP00
Insulating material	PA
Nominal Voltage	690V
Nominal Current	245A

Connection data

Conductor cross-section solid min/max	1xAl/Cu 6 / 95 mm ²
Conductor cross-section stranded min/max	1xAl/Cu 6 / 95 mm ²
Stripping length	max 20 mm / 0.79in
Screw	screw without head recessed Allen (AV) 5mm
Tightening torque	12Nm / 6-25mm ² 22Nm / 35-95mm ²

APPROVALS

EN60947-7-1 95mm² – 690V – 245A



TECHNICAL DRAWINGS

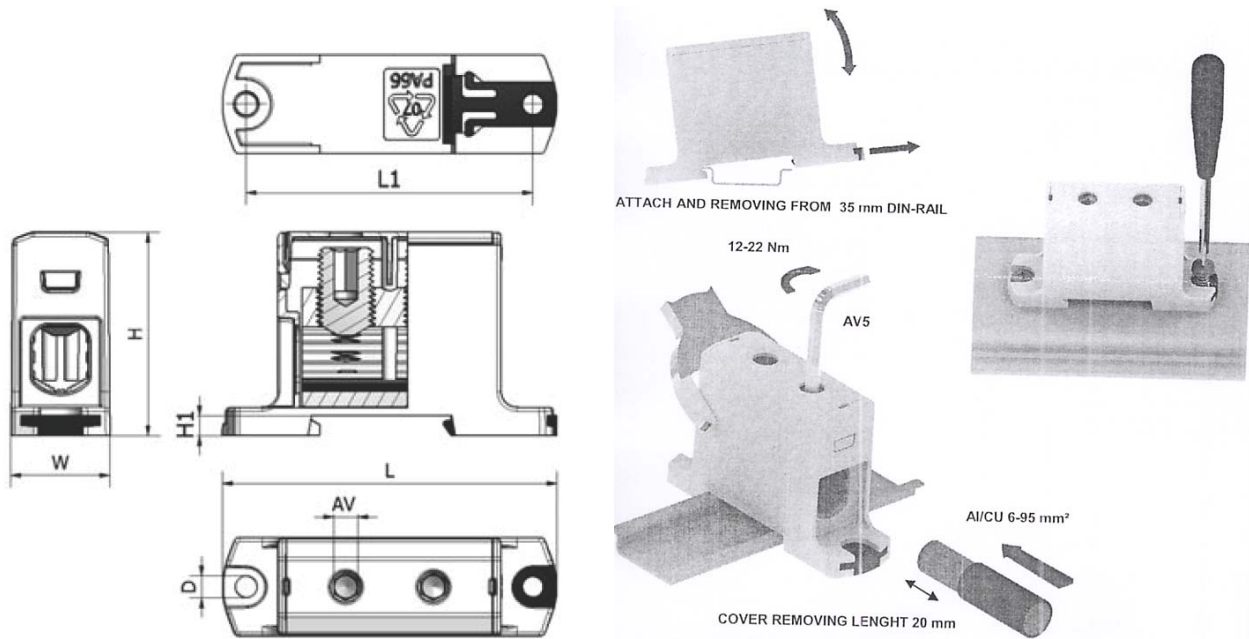

ACCESSORIES

Terminal rail systems

Item	Description
43910	Steel Omega rail 35/7,5mm - 2mt lenght
43910/F	Slotted steel Omega rail 35/7,5mm - 2mt lenght
43911	Steel Omega rail 35/15mm - 2mt lenght
43911/F	Slotted steel Omega rail 35/15mm - 2mt lenght
43028	Angled support bracket

Additional items

Item	Description
606095 BL	Universal terminal blocks for Cu/Al conductors Feed-through terminal block – Blue
606095 E	Universal terminal blocks for Cu/Al conductors Feed-through terminal block – Yellowgreen