

# EURO PRO 240

Article: **606240 BL**

Universal terminal blocks for **Cu/Al** conductors  
 Feed-through terminal block – blue  
 Screw connection system - 1xAl/Cu 35/240mm<sup>2</sup>  
 The conductive parts are made of tin-plated aluminium.



## GENERAL INFORMATION

Series	<b>EURO PRO</b>
Item	<b>606240 BL</b>
Weight/Piece	<b>195 g</b>
Customs tariff	<b>85369010</b>
Page/Catalog	<b>- / -</b>
Colour	<b>Blue</b>
Q.ty p.pck.	<b>3</b>
Q.ty p. box	<b>-</b>

## TECHNICAL DATA / DIMENSIONS

### Dimensions

Width mm(in.)	37 (1.46)
Length mm(in.)	106 (4.18)
Length (L1) mm(in.)	94 (3.7)
Height mm(in.)	65 (2.56)
Height (H1) mm(in.)	5 (0.2)
Mounting type	Omega TH35

### Technical data

Protection degree (IP)	IP00
Insulating material	PA
Nominal Voltage	690V
Nominal Current	425A

### Connection data

Conductor cross-section solid min/max	1xAl/Cu 35/240mm <sup>2</sup>
Conductor cross-section stranded min/max	1xAl/Cu 35/240mm <sup>2</sup>
Stripping length	max 30 mm / 1.18in
Screw	screw without head recessed Allen (AV) 6mm
Tightening torque	26Nm / 35-120mm <sup>2</sup> 55Nm / 150-240mm <sup>2</sup>

## APPROVALS

EN60947-7-1      240mm<sup>2</sup> – 690V – 425A



## TECHNICAL DRAWINGS

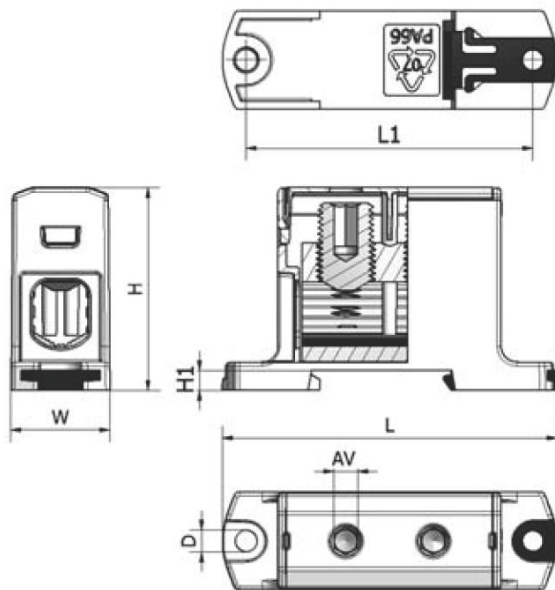

## ACCESSORIES

### Terminal rail systems

Item	Description
<b>43910</b>	Steel Omega rail 35/7,5mm - 2mt length
<b>43910/F</b>	Slotted steel Omega rail 35/7,5mm - 2mt length
<b>43911</b>	Steel Omega rail 35/15mm - 2mt length
<b>43911/F</b>	Slotted steel Omega rail 35/15mm - 2mt length
<b>43028</b>	Angled support bracket

### Additional items

Item	Description
<b>606240</b>	Universal terminal blocks for <b>Cu/Al</b> conductors Feed-through terminal block – Grey
<b>606240 E</b>	Universal terminal blocks for <b>Cu/Al</b> conductors Feed-through terminal block – Yellowgreen