

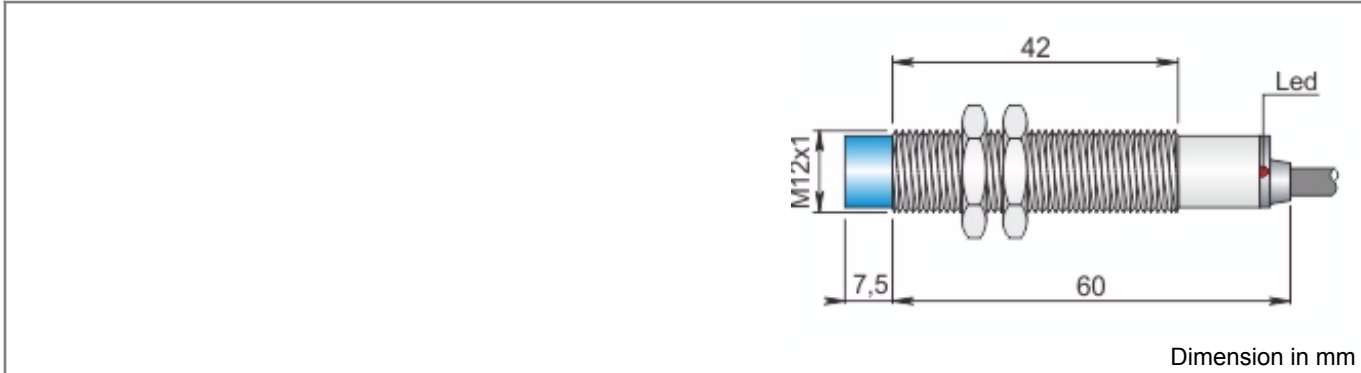

Part number: I12000177 - Model: SI12-AE4 NC LC5



TECHNICAL CHARACTERISTICS	
Power supply:	Alternating current
Working voltage:	20 ÷ 250 Vac
Switching distance (mm):	4
Function:	NC
Hysteresis (%Sn):	< 10%
Max switching frequency:	12 Hz
Repeatability (%Sn):	< = 3
Max output current:	300 mA
Min output current:	5 mA
Max peak current for 20msec:	1.5 A
Residual current:	< 1 mA
Voltage drop:	< 6 V
Led indicator:	Present
Temperature limits:	-25 ÷ +70 °C
IP rating:	IP 67
Housing material:	Nickelled brass
Mechanical characteristics:	M12x1
Connection type:	Cable 5 m
Cable type:	2x0.25 PVC
Weight:	150 g



Part number: I12000177 - Model: SI12-AE4 NC LC5

WIRING DIAGRAM

2 WIRES CABLE

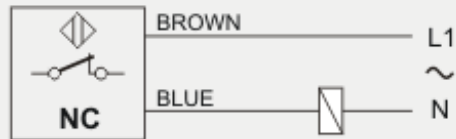

INSTRUCTIONS FOR CORRECT INSTALLATION

INSTRUCTIONS FOR CORRECT INSTALLATION

NOT EMBEDDABLE

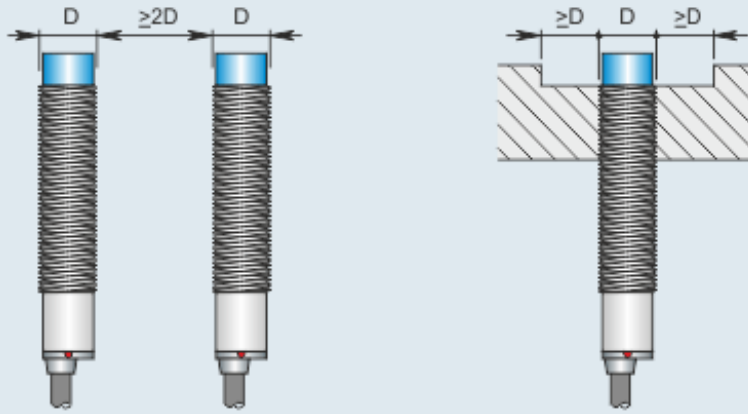

Side by side mounting

Non flush mounting