

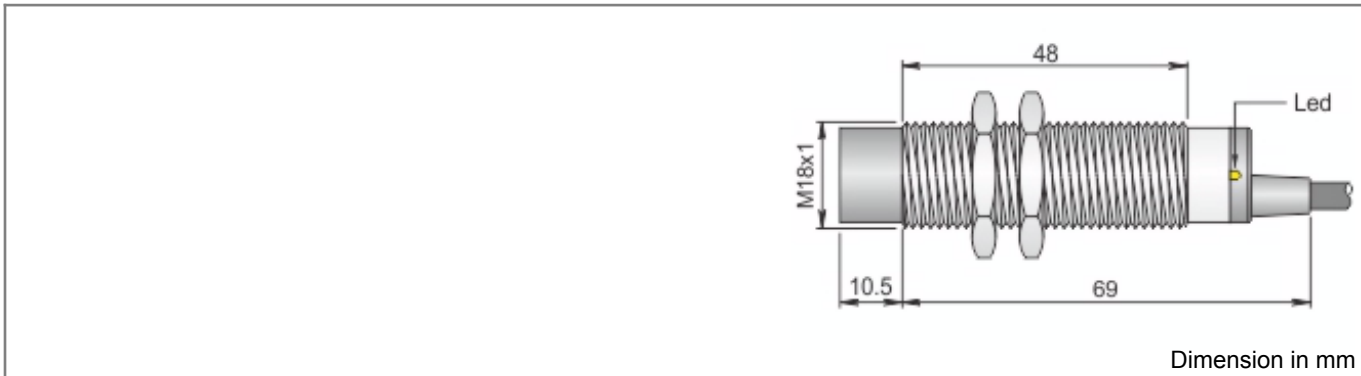

Part number: I18000462 - Model: SI18-DCE16 NPN NC LC5



TECHNICAL CHARACTERISTICS	
Power supply:	Direct current
Working voltage:	10 ÷ 30 Vdc
Switching distance (mm):	16
Output logic:	NPN
Function:	NC
Hysteresis (%Sn):	< 10%
Max switching frequency:	200 Hz
Repeatability (%Sn):	< = 3
Max output current:	200 mA
Absorption:	< 15 mA @ 24Vdc
Voltage drop:	< 1.8 V
Short circuit protection:	Present
Led indicator:	Present
Temperature limits:	-25 ÷ +85 °C
IP rating:	IP 67
Housing material:	Nickelled brass
Mechanical characteristics:	M18x1
Connection type:	Cable 5 m
Cable type:	3x0.35 PVC
Weigth:	220 g



Part number: I18000462 - Model: SI18-DCE16 NPN NC LC5

WIRING DIAGRAM

3 WIRES CABLE - LOGIC NPN NC



INSTRUCTIONS FOR CORRECT INSTALLATION

INSTRUCTIONS FOR CORRECT INSTALLATION

NOT EMBEDDABLE

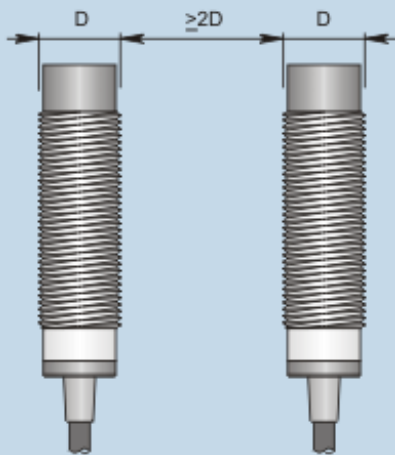

Side by side mounting

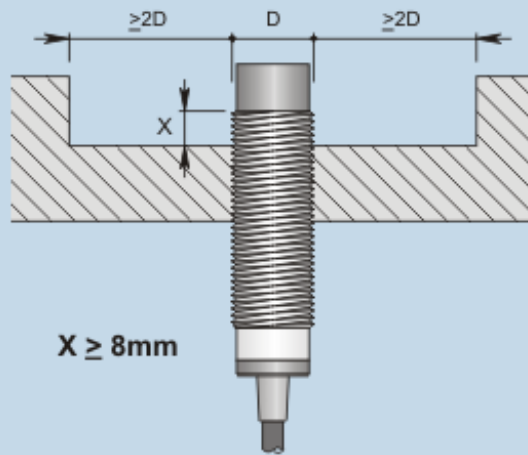

Non flush mounting