

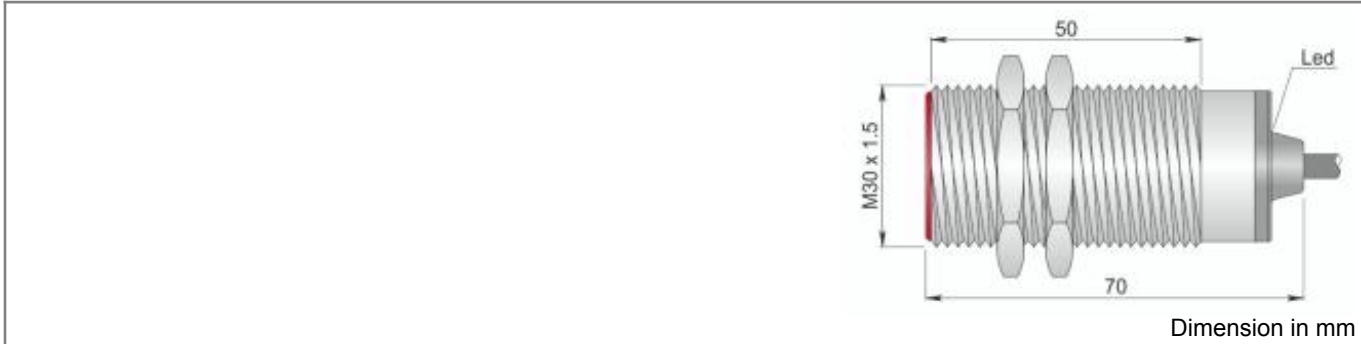

Part number: I30000173 - Model: SI30-C10 NPN NO LC5



TECHNICAL CHARACTERISTICS	
Power supply:	Direct current
Working voltage:	10 ÷ 30 Vdc
Switching distance (mm):	10
Output logic:	NPN
Function:	NO
Hysteresis (%Sn):	< 10%
Max switching frequency:	300 Hz
Repeatability (%Sn):	< = 3
Max output current:	200 mA
Absorption:	< 15 mA @ 24Vdc
Voltage drop:	< 1.8 V
Short circuit protection:	Present
Led indicator:	Present
Temperature limits:	-25 ÷ +70 °C
IP rating:	IP 67
Housing material:	Nickelled brass
Mechanical characteristics:	M30x1.5
Connection type:	Cable 5 m
Cable type:	3x0.35 PVC
Weigth:	310 g



Part number: I30000173 - Model: SI30-C10 NPN NO LC5

WIRING DIAGRAM

3 WIRES CABLE - LOGIC NPN NO



INSTRUCTIONS FOR CORRECT INSTALLATION

INSTRUCTIONS FOR CORRECT INSTALLATION

EMBEDDABLE

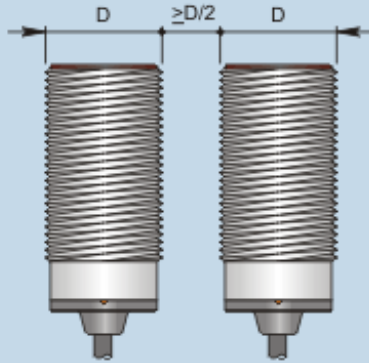

Side by side mounting

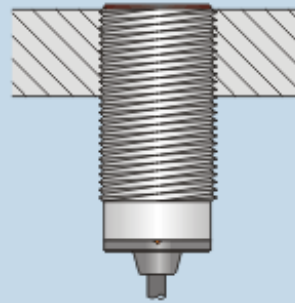

Flush mounting