



**Part number: SIA000199 - Model: SIA05-NE LC5**



<b>TECHNICAL CHARACTERISTICS</b>	
Power supply:	Direct current
Working voltage:	5 ÷ 30 Vdc
Sensing hole diameter (mm):	5
Minimum detectable object (mm):	Ø 0.7 x 1
Max switching frequency:	600 ÷ 1500 Hz
Repeatability (%Sn):	< = 0.3
Absorption:	On < = 1 mA - Off > = 3 mA @ 8.2V
Temperature limits:	-20 ÷ +60 °C
IP rating:	IP 65
Housing material:	Plastic
Mechanical characteristics:	SIA05 30x60x8
Connection type:	Cable 5 m
Cable type:	2x0.25 PVC
Weigth:	150 g



**Part number: SIA000199 - Model: SIA05-NE LC5**

**WIRING DIAGRAM**



**INSTRUCTIONS FOR CORRECT INSTALLATION**

**INSTRUCTIONS FOR CORRECT INSTALLATION**

**Fig. 1**

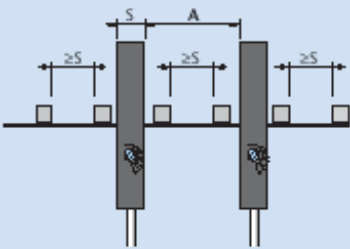

**Fig. 2**

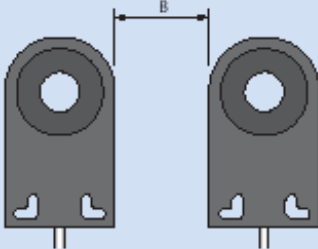

Model	SIA05	SIA12	SIA15	SIA22	SIA30	SIA44	SIA63	SIA100
A (Fig. 1) mm	25	30	30	60	60	300	300	600
B (Fig. 2) mm	10	10	10	20	20	250	250	650

## WORKING PRINCIPLE



In presence of metal  $I \leq 1 \text{ mA @ } 8.2 \text{ V}$

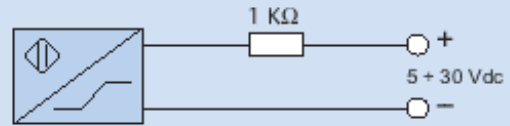

In absence of metal  $I \geq 3 \text{ mA @ } 8.2 \text{ V}$

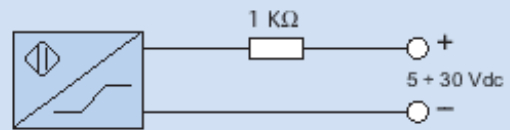

The NAMUR sensors are electronic devices whose absorbed current varies in the presence of a metallic object. The difference between these sensors and traditional sensors is the absence of amplifier trigger stages.