

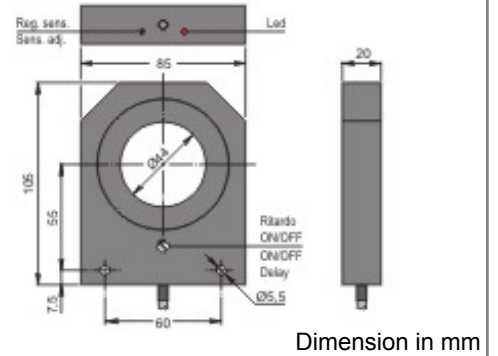

Part number: SIA000292 - Model: SIA63-CE NPN NO+NC R LC5



Dimension in mm

TECHNICAL CHARACTERISTICS

Power supply:	Direct current
Working voltage:	10 ÷ 30 Vdc
Sensing hole diameter (mm):	63
Minimum detectable object (mm):	Ø 6 x 12
Output logic:	NPN
Function:	NO+NC
Hysteresis (%Sn):	Depends on the sensitivity
Max switching frequency:	See instructions for installation
Delay ON de-energization:	100 mSec (when inserted)
Repeatability (%Sn):	< = 0.3
Max output current:	200 mA
Absorption:	< 15 mA @ 24Vdc
Voltage drop:	< 1.8 V
Short circuit protection:	Present
Led indicator:	Present
Temperature limits:	-20 ÷ +60 °C
IP rating:	IP 65
Housing material:	Plastic
Mechanical characteristics:	SIA63 85x105x20
Connection type:	Cable 5 m
Cable type:	4x0.25 PVC
Weigth:	300 g



Part number: SIA000292 - Model: SIA63-CE NPN NO+NC R LC5

WIRING DIAGRAM

4 WIRES CABLE - LOGIC NPN NO+NC

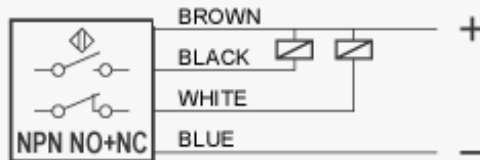

INSTRUCTIONS FOR CORRECT INSTALLATION

INSTRUCTIONS FOR CORRECT INSTALLATION

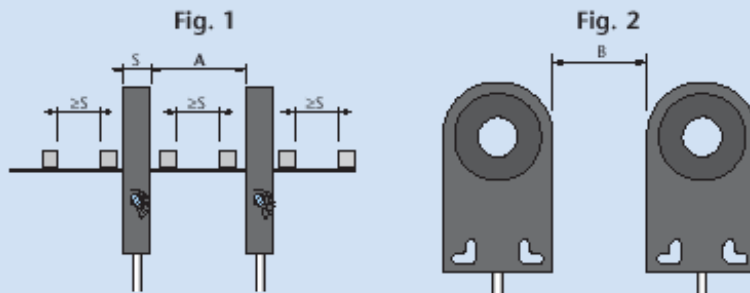

Model	SIA05	SIA12	SIA15	SIA22	SIA30	SIA44	SIA63	SIA100
A (Fig. 1) mm	25	30	30	60	60	300	300	600
B (Fig. 2) mm	10	10	10	20	20	250	250	650

MIN. DIMENSIONS OF THE OBJECT TO DETECT (Fe37)

Model	SIA63	
Lenght	mm	12
Diameter	mm	6

SWITCHING FREQUENCY

The switching frequency of inductive ring sensors depends on delayed impulse time (**when inserted**) according to the formula :

$$\text{Switching frequency (Hz)} = \frac{1}{(T \text{ impulse} + 10) \text{ mS}}$$

Vice versa, the switching frequency will be between 100+200 Hz.