

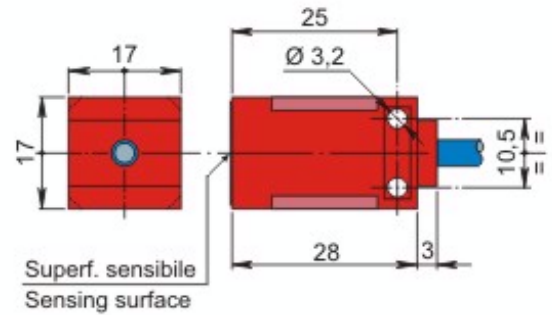

Part number: SIP000121 - Model: SIP17-NE5



Dimension in mm

TECHNICAL CHARACTERISTICS

Power supply:	Direct current
Working voltage:	5 ÷ 30 Vdc
Switching distance (mm):	5
Max switching frequency:	2000 Hz
Repeatability (%Sn):	< = 3
Absorption:	On < = 1 mA - Off > = 3 mA @ 8.2V
Temperature limits:	-25 ÷ +70 °C
IP rating:	IP 67
Housing material:	Plastic
Mechanical characteristics:	SIP 17x17x31
Connection type:	Cable 3 m
Cable type:	2x0.25 PVC
Weigth:	65 g

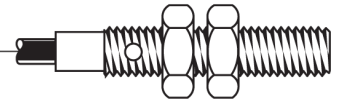

Part number: SIP000121 - Model: SIP17-NE5

WIRING DIAGRAM

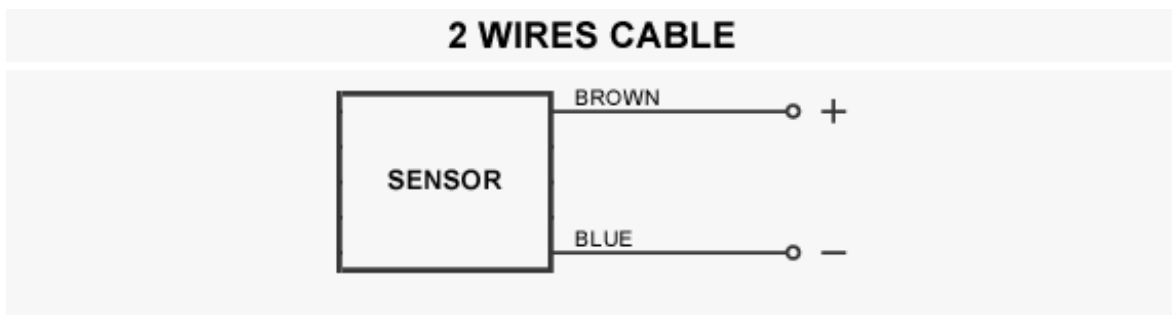

INSTRUCTIONS FOR CORRECT INSTALLATION

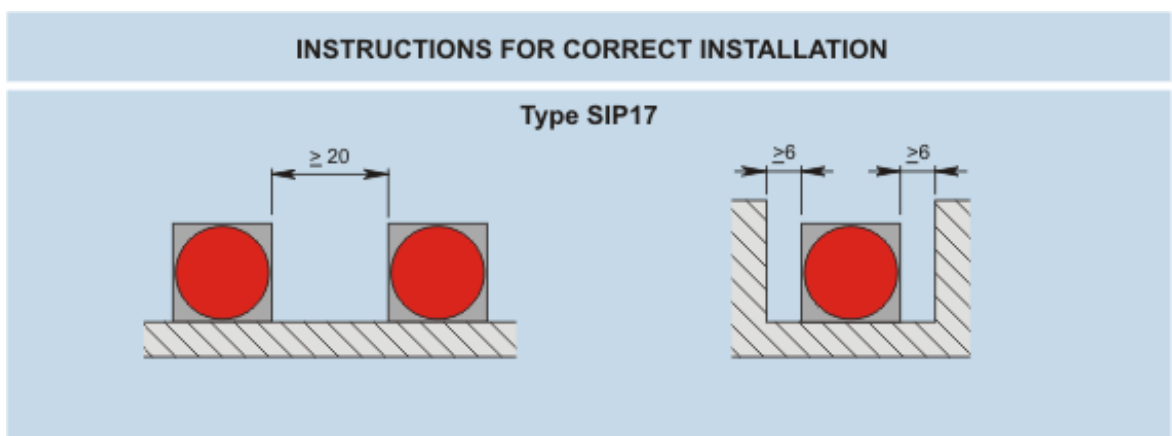

WORKING PRINCIPLE

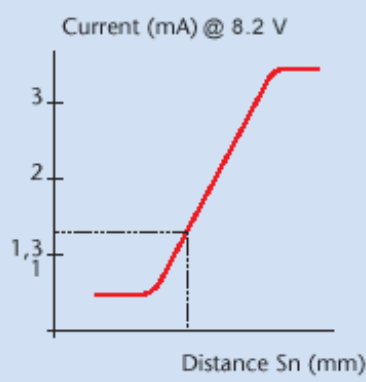

Metallic plate

In presence of metal $I \leq 1 \text{ mA @ } 8.2 \text{ V}$

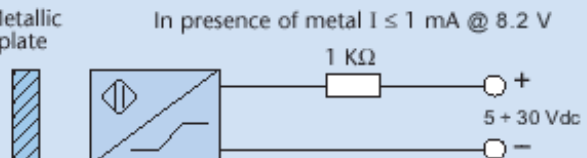

In absence of metal $I \geq 3 \text{ mA @ } 8.2 \text{ V}$

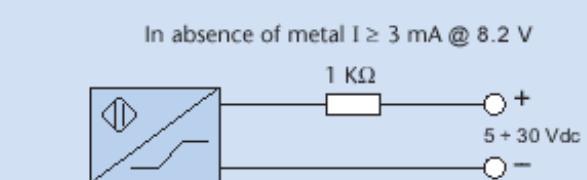

The NAMUR sensors are electronic devices whose absorbed current varies in the presence of a metallic object. The difference between these sensors and traditional sensors is the absence of amplifier trigger stages.