

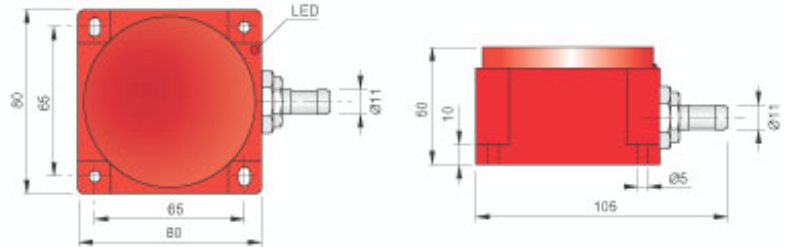

Part number: SIP000335 - Model: SIQ80-CE50 NPN NO+NC LC5



Dimension in mm

TECHNICAL CHARACTERISTICS

Power supply:	Direct current
Working voltage:	10 ÷ 55 Vdc
Switching distance (mm):	10 ÷ 60 (adjustable)
Output logic:	NPN
Function:	NO+NC
Hysteresis (%Sn):	< 10%
Max switching frequency:	50 Hz
Repeatability (%Sn):	< = 3
Max output current:	200 mA
Absorption:	< 10 mA @ 24Vdc
Voltage drop:	< 1.8 V
Short circuit protection:	Present
Led indicator:	Present
Temperature limits:	-25 ÷ +70 °C
IP rating:	IP 67
Housing material:	Plastic
Mechanical characteristics:	SIQ 80x80x50
Connection type:	Cable 5 m
Cable type:	2x0.50 PVC
Weighth:	550 g



Part number: SIP000335 - Model: SIQ80-CE50 NPN NO+NC LC5

WIRING DIAGRAM

4 WIRES CABLE - LOGIC NPN NO+NC

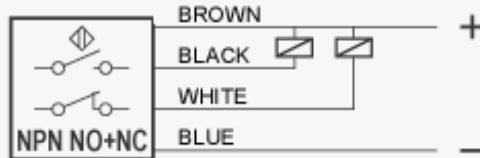

INSTRUCTIONS FOR CORRECT INSTALLATION

INSTRUCTIONS FOR CORRECT INSTALLATION

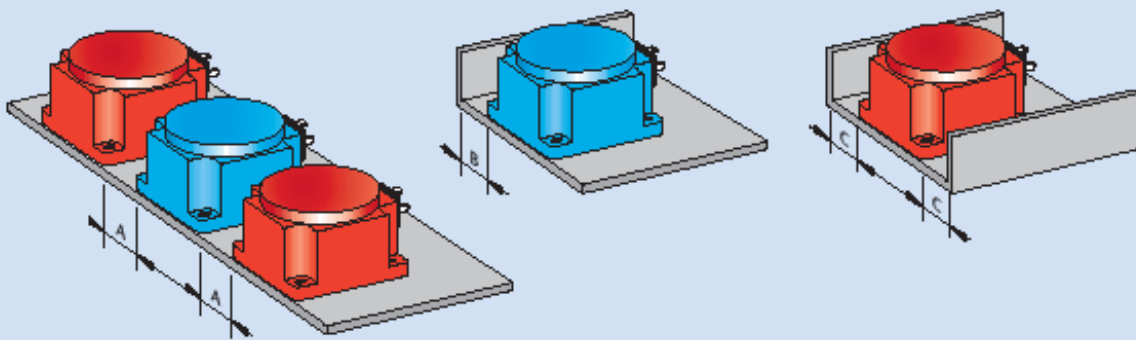

Dimensions mm	A	B	C
SIQ 80	≥450	≥45	≥70

N.B.: A-B-C ratings are referred to Sn = 35 mm. To adjust less or more sensitivity they either must be decreased or increased.

SENSITIVITY ADJUSTMENT

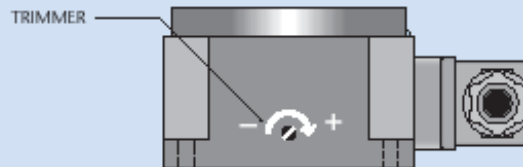

This sensor is supplied with a trimmer for the sensitivity adjustment. The sensitivity increases when the trimmer is rotated in the clockwise direction and decreases in the anti-clockwise direction. Avoid using for a capacity greater than 60 mm referred to a square piece of (FE 37) steel of 1 mm thickness the side of which is equal to 100 mm. When setting the sensor keep in consideration all other metallic objects nearby, in fact setting is suggested to be made when the sensor is installed in the normal working conditions. The sensor is supplied already pre-set to 50 mm sensitivity.