

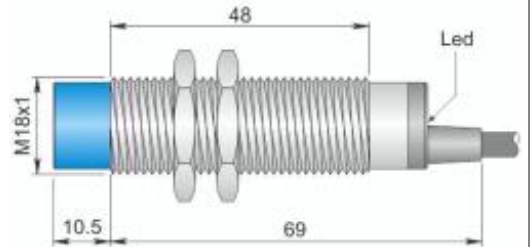

Part number: Y18000062 - Model: SI18-AE8 NC AD3 LC5



Dimension in mm

TECHNICAL CHARACTERISTICS

Power supply:	Alternating current
Working voltage:	20 ÷ 250 Vac
Switching distance (mm):	8
Function:	NC
Hysteresis (%Sn):	< 10%
Max. switching frequency:	12 Hz
Repeatability (%Sn):	< = 3
Max. output current:	200 mA
Min. output current:	5 mA
Max. peak current for 20msec:	1.5 A
Residual current:	< 1 mA
Voltage drop:	< 6 V
Led indicator:	Present
Operating temperature range:	-25 ÷ +60 °C
Storage temperature range:	-25 ÷ +70 °C
Max. surface temperature:	+85 °C
Mechanical characteristics:	M18x1
Connection type:	Cable 5 m
Limiting device of surface temperature:	Intervention at 75 ° C non-resettable
IP rating:	IP67
Cable type:	2x0.35 PVC shielded
Weigth:	100g
Explosive atmosphere type:	Air/Dust mixture
Equipment category:	3D
Installation area:	Zone 22
Protection method:	Protection by enclosure
Marking:	II 3D Ex tc IIIC T85°C Dc IP67 X -25< Ta
Conforming standard:	EN60079-0, EN60079-31, EN61000-6-2, EN61000-6-4 and EN60947-5-2

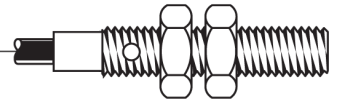

Part number: Y18000062 - Model: SI18-AE8 NC AD3 LC5

WIRING DIAGRAM

2 WIRES CABLE

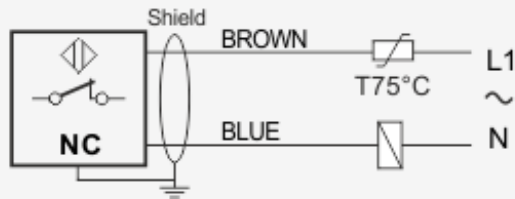

INSTRUCTIONS FOR CORRECT INSTALLATION

INSTRUCTIONS FOR CORRECT INSTALLATION

NOT EMBEDDABLE

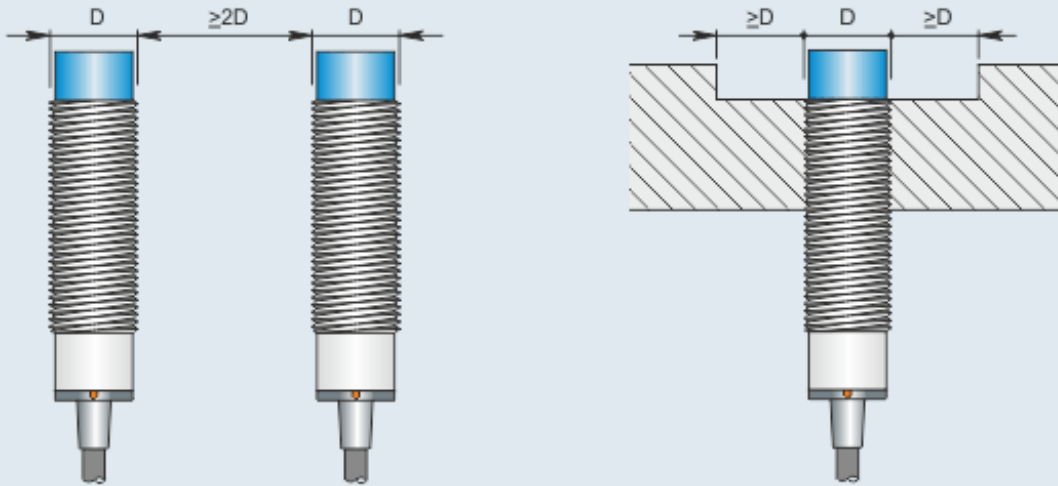

Side by side mounting

Non flush mounting