

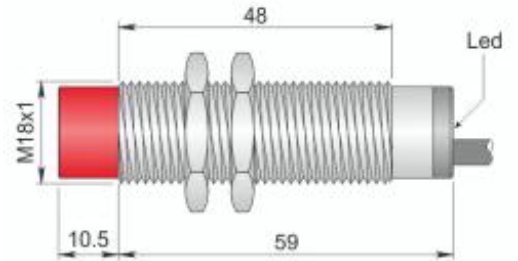

**Part number: Y18000079 - Model: SI18-CE8 NPN NO AD3 LC5**



Dimension in mm

**TECHNICAL CHARACTERISTICS**

Power supply:	Direct current
Working voltage:	10 ÷ 30 Vdc
Switching distance (mm):	8
Output logic:	NPN
Function:	NO
Hysteresis (%Sn):	< 10%
Max. switching frequency:	1000 Hz
Repeatability (%Sn):	< = 3
Max. output current:	200 mA
Absorption:	< 15 mA @ 24Vdc
Voltage drop:	< 1.8 V
Short circuit protection:	Present
Led indicator:	Present
Operating temperature range:	-25 ÷ +60 °C
Storage temperature range:	-25 ÷ +70 °C
Max. surface temperature:	+85 °C
Mechanical characteristics:	M18x1
Connection type:	Cable 5 m
Limiting device of surface temperature:	Intervention at 75 ° C non-resettable
IP rating:	IP67
Cable type:	3x0.35 PVC shielded
Weigth:	100g
Explosive atmosphere type:	Air/Dust mixture
Equipment category:	3D
Installation area:	Zone 22
Protection method:	Protection by enclosure
Marking:	II 3D Ex tc IIIC T85°C Dc IP67 X -25< Ta
Conforming standard:	EN60079-0 e EN60079-31



Part number: Y18000079 - Model: SI18-CE8 NPN NO AD3 LC5

## WIRING DIAGRAM

### 3 WIRES CABLE - LOGIC NPN NO

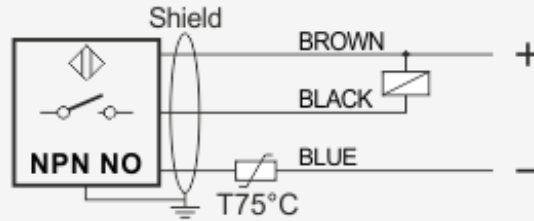

## INSTRUCTIONS FOR CORRECT INSTALLATION

### INSTRUCTIONS FOR CORRECT INSTALLATION

#### NOT EMBEDDABLE

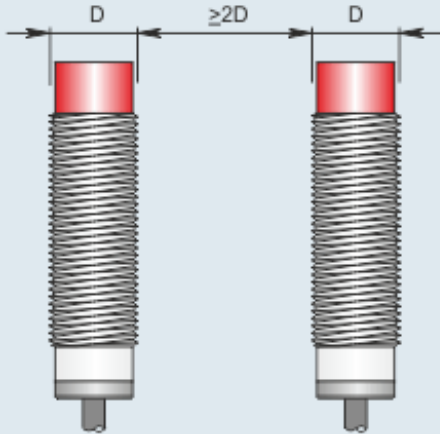

Side by side mounting

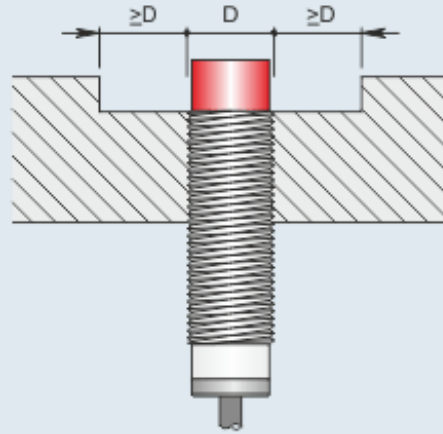

Non flush mounting