

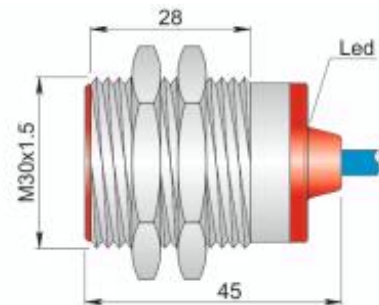

**Part number: Y30000040 - Model: SI30-N10 LC5 AGD1**



Dimension in mm

### TECHNICAL CHARACTERISTICS

Power supply:	Direct current
Working voltage:	8.2 Vdc (1Kohm)
Switching distance (mm):	10
Output type:	Namur
Hysteresis (%Sn):	1 ÷ 10
Max. switching frequency:	500 Hz
Repeatability (%Sn):	< = 3
Current absorption at 8.2V:	Target detected < = 1 mA - Target not detected >= 3 mA
Led indicator:	Present
Operating temperature limits:	-25 ÷ +60 °C
Storage temperature limits:	-30 ÷ +70 °C
IP rating:	IP 67
Housing material:	Nickelled brass
Cable type:	2x0.50 mm <sup>2</sup> PVC
Weight:	260 g
Mechanical characteristics:	M30x1.5
Connection type:	Cable 5 m
Explosive atmosphere type:	Mixture Air/gas and/or Air/Dust
Equipment category:	1G / 1D
Installation area:	Gas: Zone 0, Zone 1 and Zone 2 - Dust: Zone 20, Zone 21 and Zone22
Protection method:	Intrinsically safe
Marking:	Gas: II 1G Ex ia IIC T6 Ga - Dust: II 1D Ex ia IIIC T85°C Da -25< Ta
Safety information:	Connection to certified intrinsically safe circuits only with the following values : Uo < = 17 V ,
Conforming standard:	EN60079-0, EN60079-11, EN60079-26 and EN60947-5-6
EC-type examination certificate - ATEX:	IMQ 13 ATEX 019
Certificate of conformity (CoC) - IECEx:	IECEx IMQ 13.0012X



Part number: Y30000040 - Model: SI30-N10 LC5 AGD1

### WIRING DIAGRAM

#### 2 WIRES CABLE

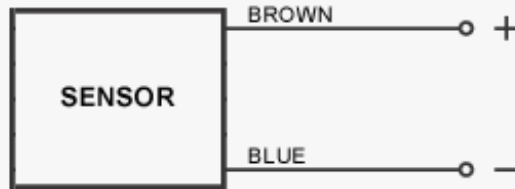

### INSTRUCTIONS FOR CORRECT INSTALLATION

#### INSTRUCTIONS FOR CORRECT INSTALLATION

##### EMBEDDABLE

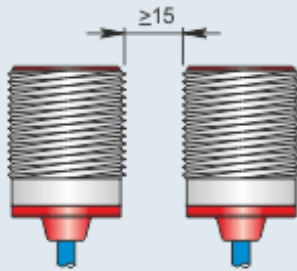

Side by side mounting

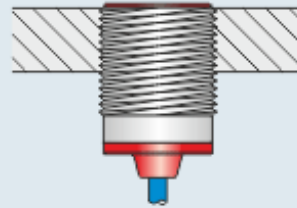

Flush mounting

### WORKING PRINCIPLE

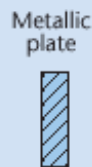
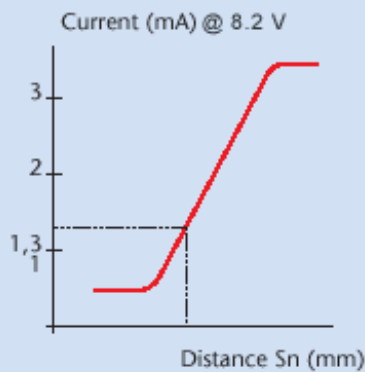

In presence of metal  $I \leq 1 \text{ mA @ } 8.2 \text{ V}$

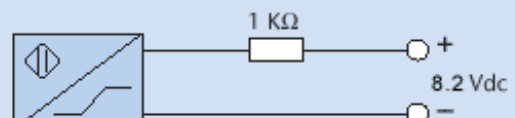

In absence of metal  $I \geq 3 \text{ mA @ } 8.2 \text{ V}$

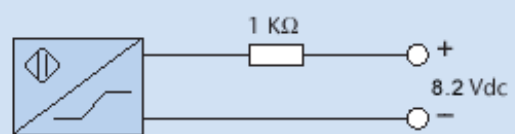

The NAMUR EX sensors are electronic devices whose absorbed current varies in the presence of a metallic object. The difference between these sensors and traditional sensors is the absence of amplifier trigger stages.

