

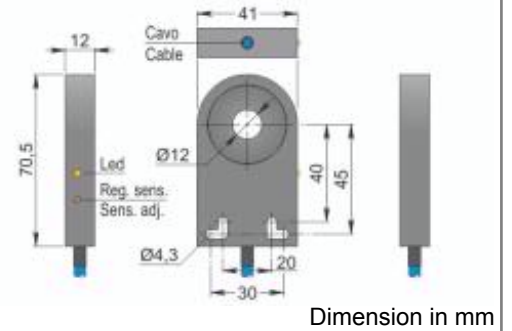

Part number: YIA000056 - Model: SIA12-NE LC5 AGD1



TECHNICAL CHARACTERISTICS

Power supply:	Direct current
Working voltage:	8.2 Vdc (1Kohm)
Sensing hole diameter (mm):	12
Minimum detectable object (mm):	Ø 1.2 x 2
Output type:	Namur
Max. switching frequency:	600 ÷ 1000 Hz
Repeatability (%Sn):	< = 0.3
Current absorption at 8.2V:	Target detected < = 1 mA - Target not detected >= 3 mA
Led indicator:	Present
Operating temperature limits:	-25 ÷ +60 °C
Storage temperature limits:	-30 ÷ +70 °C
IP rating:	IP 67
Housing material:	Plastic
Cable type:	2x0.25 mm ² PVC
Weight:	150 g
Mechanical characteristics:	SIA05 41x70x12
Connection type:	Cable 5 m
Explosive atmosphere type:	Mixture Air/gas and/or Air/Dust
Equipment category:	1G / 1D
Installation area:	Gas: Zone 0, Zone 1 and Zone 2 - Dust: Zone 20, Zone 21 and Zone22
Protection method:	Intrinsically safe
Marking:	Gas: II 1G Ex ia IIB T5 Ga - Dust: II 1D Ex ia IIIC T100°C Da IP66 -25< Ta
Safety information:	Connection to certified intrinsically safe circuits only with the following values : Uo < = 17 V ,
Conforming standard:	EN60079-0, EN60079-11, EN60079-26 and EN60947-5-6
EC-type examination certificate - ATEX:	IMQ 13 ATEX 019
Certificate of conformity (CoC) - IECEx:	IECEx IMQ 13.0012X



Part number: YIA000056 - Model: SIA12-NE LC5 AGD1

WIRING DIAGRAM



INSTRUCTIONS FOR CORRECT INSTALLATION

INSTRUCTIONS FOR CORRECT INSTALLATION

Fig. 1

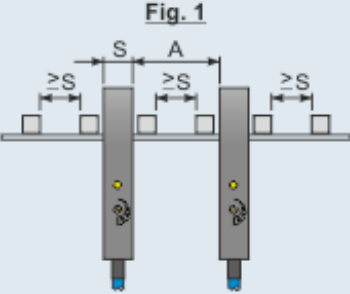
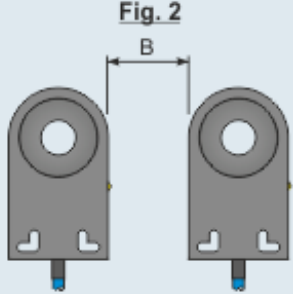

Fig. 2



Model	SIA05	SIA12	SIA15	SIA22	SIA30	SIA44	SIA63
A (Fig. 1) mm	25	30	30	60	60	300	300
B (Fig. 2) mm	10	10	10	20	20	250	250

WORKING PRINCIPLE



In presence of metal $I \leq 1 \text{ mA @ } 8.2 \text{ V}$



In absence of metal $I \geq 3 \text{ mA @ } 8.2 \text{ V}$



The NAMUR EX sensors are electronic devices whose absorbed current varies in the presence of a metallic object. The difference between these sensors and traditional sensors is the absence of amplifier trigger stages.