

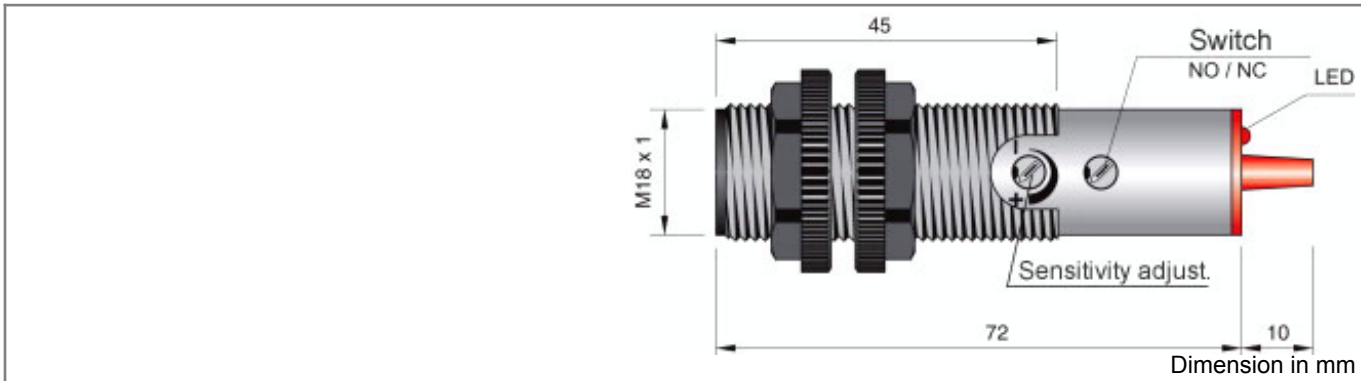

Part number: FT1000094 - Model: FT18-ABR LC5



TECHNICAL CHARACTERISTICS	
Power supply:	Alternating current
Working voltage:	20 ÷ 250 Vac
Switching distance (cm):	0 ÷ 1500 (adjustable)
Output type:	AC
Function:	NO/NC
Actuation type:	Instantaneous
Light source:	Infrared
Power on delay:	< = 75 mSec
Max switching frequency:	15 Hz
Max output current:	300 mA
Max peak current for 20msec:	3:00 AM
Absorption:	< = 10 mA
Voltage drop:	1.5 V
Short circuit protection:	Present
Interference from external light:	> 10000 Lux
Led indicator:	Red = operation indicator
Temperature limits:	-20 ÷ +50 °C
IP rating:	IP 67
Housing material:	Grey Makrolon
Mechanical characteristics:	M18x1
Connection type:	Cable 5 m
Cable type:	3x0.35 PVC
Weight:	190 g



Part number: FT1000094 - Model: FT18-ABR LC5

WIRING DIAGRAM

3 WIRES CABLE

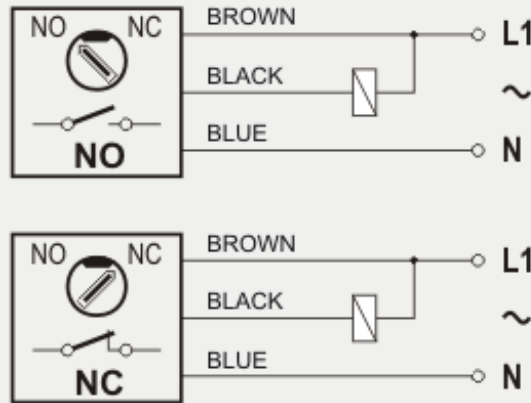

INSTRUCTIONS FOR CORRECT INSTALLATION

TYPES

Thru beam emitter + receiver (B type)



INSTRUCTIONS FOR THE PROGRAMMING AND ADJUSTMENT

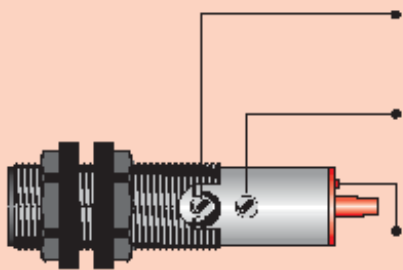

- TRIMMER FOR THE SENSING RANGE ADJUSTMENT:** The photocell is supplied with max. sensing range with the trimmer totally rotated in the clockwise direction. The sensitivity reduces by rotating the trimmer in the anti-clockwise direction.
- SWITCH NO/NC:** The photocell is supplied with switch in NO position (in absence of the object to be detected the output is deactivated). To change to N.C. (in absence of the object to be sensed the output is activated) turn the switch to N.C. in the anti-clockwise direction.
- LED FOR INDICATION OF OPERATION:** This indicates the output of the photocell, in the absence of the object to be sensed it is off with output N.O. and is on with output N.C. this changes state when the object to be sensed enters into the sensing area of the photocell.

NOTE! Before giving a power supply to the photocell it is recommended that the same unit be programmed by using the switch in the required function NO or NC.

NOTE! It is recommended that the trimmer and the switch be rotated very carefully by using a proper tool otherwise these can be seriously damaged.

CHARACTERISTIC CURVES OF FT18M - FT18 - FT18EL - FTQ TYPES

FT18M-CBE + FT18M-CBR
FT18-ABE + FT18-ABR
FT18EL-CBE + FT18EL-CBR

