

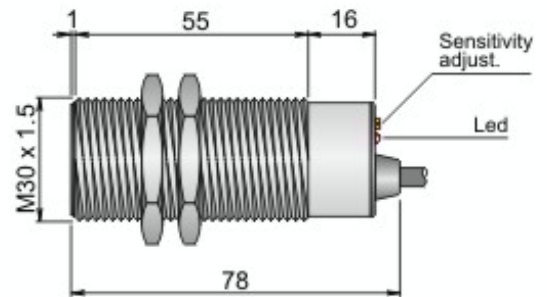

Part number: C3000037 - Model: SC30SM-C20 PNP NO+NC LC5



Dimension in mm

TECHNICAL CHARACTERISTICS

Working voltage:	10 ÷ 55 Vdc
Output type:	DC PNP
Function:	NO+NC
Actuation type:	Instantaneous
Sensing distance (mm):	0 ÷ 20 (adjustable)
Hysteresis (%Sn):	Depends on the switching distance
Max. switching frequency:	10 Hz
Repeatability (%Sn):	< 1
Max. output current:	300 mA
Absorption:	< = 10 mA @ 24Vdc
Voltage drop:	< 1.8 V
Short circuit protection:	Present
Led indicator:	Present
Shielding:	Embeddable
Mechanical characteristics:	M30x1.5
Housing material:	Nickelled brass
Connection type:	Cable 5 m
Cable type:	4x0.25 PVC
Temperature limits:	-20 ÷ +70 °C
IP rating:	IP 67
Weight:	350 g



Part number: C3000037 - Model: SC30SM-C20 PNP NO+NC LC5

WIRING DIAGRAM

4 WIRES CABLE - LOGIC PNP NO+NC



INSTRUCTIONS FOR CORRECT INSTALLATION

INSTRUCTIONS FOR CORRECT INSTALLATION

EMBEDDABLE

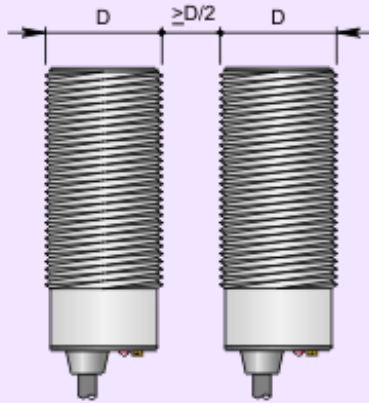

Side by side mounting

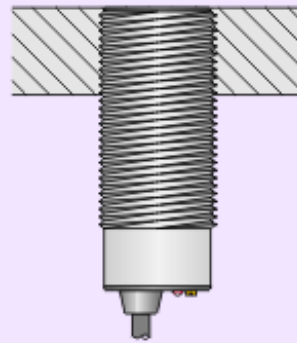

Flush mounting