

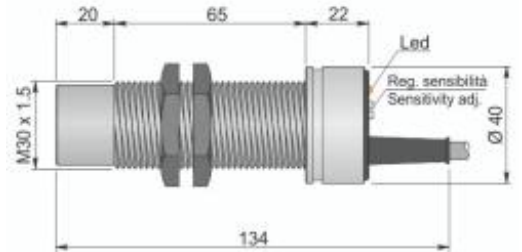

Part number: YC300044 - Model: SC30P-RE25 TA1' AD3 LC5



Dimension in mm

TECHNICAL CHARACTERISTICS

Working voltage:	12 ÷ 240 Vac/dc
Output type:	AC/DC
Function:	Changeover relay
Actuation type:	Delayed
Delay range (min):	0 ÷ 1
Sensing distance (mm):	0 ÷ 25 (adjustable)
Hysteresis (%):	Depends on the switching distance
Max. switching frequency:	Depends on delay
Repeatability (%Sn):	< 1
Max. output current:	1 A @ 220 Vac
Absorption:	< 20 mA @ relay activated
Led indicator:	Present
Shielded:	Not embeddable
Mechanical characteristics:	M30x1.5
IP rating:	IP 67
Housing material:	Polycarbonate/Nickelled brass
Connection type:	Cable 5 m
Cable type:	5x0.35 PVC shielded
Weight:	430 g
Operating temperature range:	-25 ÷ +60 °C
Storage temperature range:	-25 ÷ +70 °C
Max. surface temperature:	+85 °C
Limiting device of surface temperature:	Intervention at 75 ° C non-resettable
Explosive atmosphere type:	Air/Dust mixture
Equipment category:	3D
Installation area:	Zone 22
Protection method:	Protection by enclosure
Marking:	II 3D Ex tc IIIC T85°C Dc X-25< Ta
Conforming standard:	EN60079-0, EN60079-31, EN61000-6-2, EN61000-6-4 and EN60947-5-2



Part number: YC3000044 - Model: SC30P-RE25 TA1' AD3 LC5

WIRING DIAGRAM

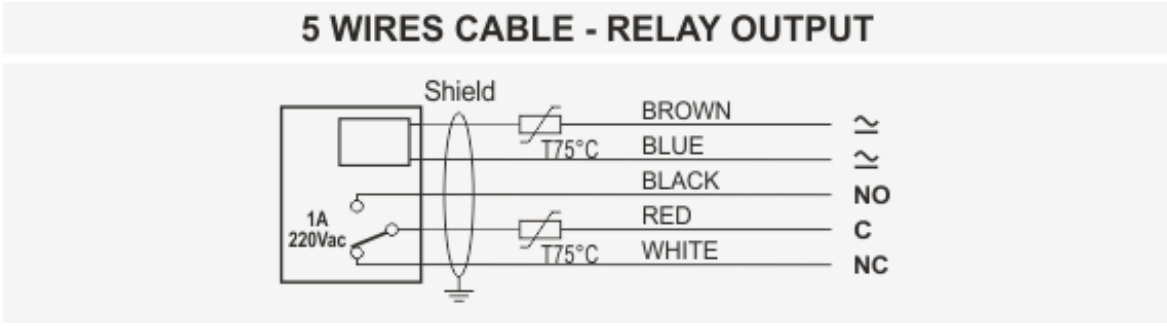

INSTRUCTIONS FOR CORRECT INSTALLATION

