

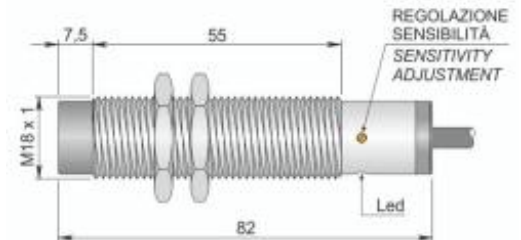

Part number: YC800024 - Model: SC18SM-AE10 NO AD3 LC5



Dimension in mm

TECHNICAL CHARACTERISTICS

Working voltage:	20 ÷ 250 Vac
Output type:	AC
Function:	NO
Actuation type:	Instantaneous
Sensing distance (mm):	0 ÷ 10 (adjustable)
Hysteresis (%):	< = 20
Max. switching frequency:	10 Hz
Repeatability (%Sn):	< 10
Max. output current:	300 mA
Min. output current:	10 mA (minimum current for release)
Max. peak current for 20msec:	1.5 A
Residual current:	< = 1 mA
Voltage drop:	< 6 V
Led indicator:	Yellow
Shielded:	Not embeddable
Mechanical characteristics:	M18X1
IP rating:	IP 67
Housing material:	Nickelled brass
Connection type:	Cable 5 m
Cable type:	3x0.35 PVC shielded
Weight:	360 g
Operating temperature range:	-25 ÷ +60 °C
Storage temperature range:	-25 ÷ +70 °C
Max. surface temperature:	+85 °C
Limiting device of surface temperature:	Intervention at 75 ° C non-resettable
Explosive atmosphere type:	Air/Dust mixture
Equipment category:	3D
Installation area:	Zone 22
Protection method:	Protection by enclosure
Marking:	II 3D Ex tc IIIC T85°C Dc X-25< Ta
Conforming standard:	EN60079-0, EN60079-31, EN61000-6-2, EN61000-6-4 and EN60947-5-2

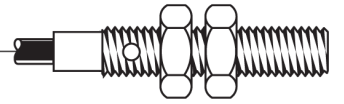

Part number: YC800024 - Model: SC18SM-AE10 NO AD3 LC5

WIRING DIAGRAM

2 WIRES + GROUND CABLE

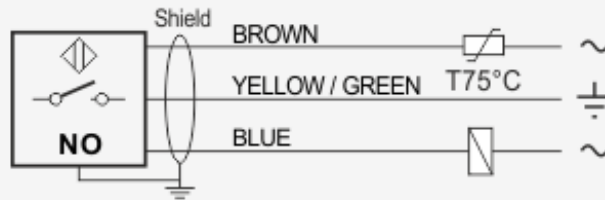

INSTRUCTIONS FOR CORRECT INSTALLATION

INSTRUCTIONS FOR CORRECT INSTALLATION

NOT EMBEDDABLE

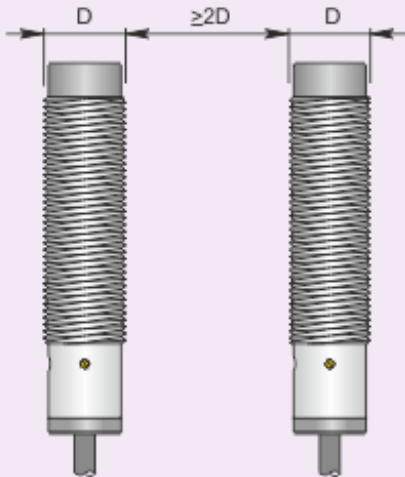

Side by side mounting

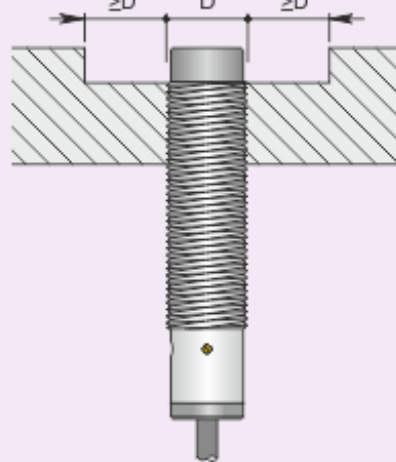

Non flush mounting