

Horns and Sirens / Heavy-Duty multi-tone sounder
Multi-t.sounder WM 32 tne 115-230VAC GY

Part No.: 141.100.68

**MECHANICAL DATA**

Length	132 mm
Width	165 mm
Height	136 mm
Materials	PC/ABS
Housing colour	Grey
Protection category	IP66
Connection	Screw terminals
cross-sectional area maximum	2,50mm ² / 14AWG
Cable entry	Screwed cable gland
Cable entry minimum	d = 8 mm
Cable entry maximum	d = 12 mm
Tension relief	Present (conforms to VDI)
Type of fixing	Wall mounting
Service life optical	5,000 h minimum
Acoustic service life	5,000 h minimum
Working temperature minimum	-25°C
Working temperature maximum	+70°C
Weight with packaging	665 g
Product weight	575 g

ELECTRICAL DATA

Operating voltage	115-230V
Operating voltage type	AC
Operating voltage type	50Hz at 230V 60Hz at 115V
Operating voltage tolerance	+/- 10%
Rated operational voltage	230 VAC
Rated operational current	22 mA
Protection class	Protection class 2
Pollution degree	3
Overvoltage category	II
Isolation voltage	Ui = 250V; Uimp = 2.500V

ACUSTICAL DATA

Volume/dB(max) at 1m distance	110,0 dB dB(A)
Acoustic signal image	Multi-tone
Number of tones	32 tone



For additional installation and mounting information, refer to the appropriate user guide at www.werma.com. This printed copy is for information only and is subject to alteration.

Horns and Sirens / Heavy-Duty multi-tone sounder
Multi-t.sounder WM 32 tne 115-230VAC GY

DRAWING

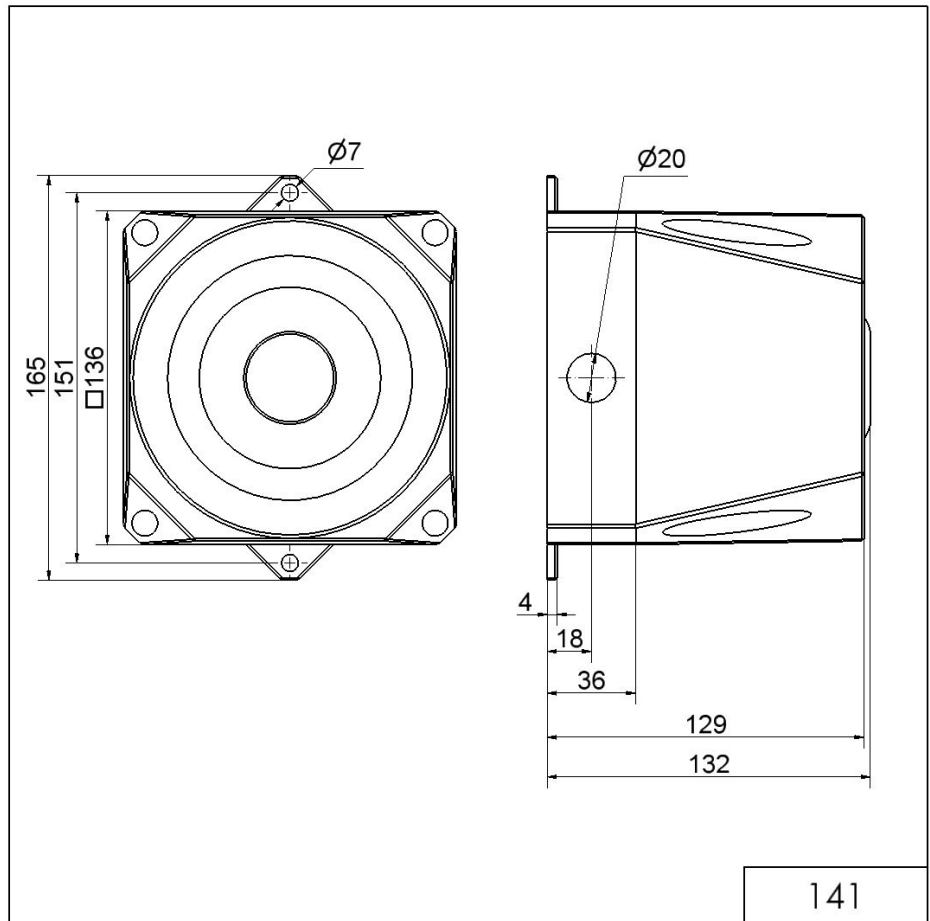

! For additional installation and mounting information, refer to the appropriate user guide at www.werma.com. This printed copy is for information only and is subject to alteration.