



MBA 361280
Article No. 0101102400

Material: Aluminium
Protection class: IP66

MBA-Enclosures are universal, sturdy and easily adapt to the installation of electrical, electronic and pneumatic components. Manufacturing takes place using pressure die casting or gravity die casting methods.

MBA-Enclosures can be mechanically processed in a number of ways providing almost no limits to customised surface design.

As terminal enclosures they can be assembled according to a modular system with the addition of differing clamps and cable glands. In the measurement and control technology market they are often used for encapsulating sensors. Additionally they serve as junction boxes for cables and lines or take on the job of protecting highly sensitive electronics against water, dirt and dust.



We would be glad to assist you!

MULTI-BOX GmbH

Wallücker Bahndamm 7
D-32278 Kirchlengern
Tel. +49 (0)5223 49107-0

info@multi-box.com
www.multi-box.com

Dimensions and weight

Length (mm)	360
Width (mm)	122
Height (mm)	80
Weight (g)	2300

Color information

Color description cover	Light Grey
RAL-code cover	7001
Color description base	Light Grey
RAL-code base	7001

Technical Drawings

PDF	
DXF	
3D	



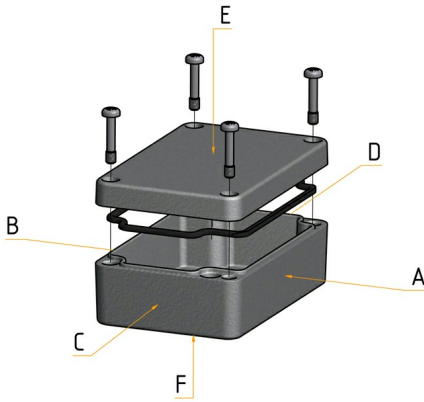

We would be glad to assist you!

MULTI-BOX GmbH

Wallücker Bahndamm 7
D-32278 Kirchlegern
Tel. +49 (0)5223 49107-0

info@multi-box.com
www.multi-box.com



Material information

Material cover	Aluminium
Material base	Aluminium
Material sealing	Polyurethane
Material screws	Stainless Steel V2 A
Silicone-free	<input checked="" type="checkbox"/>
Halogen-free	<input checked="" type="checkbox"/>
UV-resistant	<input checked="" type="checkbox"/>
Surface coating	Powder coating

Temperature resistance and application areas

Permanent operating temperature max. (°C)	100
Permanent operating temperature min. (°C)	-40
Permanent operating temperature with special sealing max. (°C)	140
Permanent operating temperature with special sealing min. (°C)	-50
Suitable for outdoor use	<input checked="" type="checkbox"/>
Suitable for indoor use	<input checked="" type="checkbox"/>

Technical specifications



















Protection class IP	66
Norm of protection class	DIN EN 60529
Earthing point available	<input checked="" type="checkbox"/>
Sealing foamed seamless	<input checked="" type="checkbox"/>
Captive cover screws	<input checked="" type="checkbox"/>
Assembly tool	PZ2
Tightening torque cover screws max. (Nm)	4.00
Tightening torque cover screws min. (Nm)	2.00
Tightening torque earthing screw max. (Nm)	2.70
Tightening torque earthing screw min. (Nm)	1.50



Modifications and Services

Mechanical processing	✓
Finishing and Assembly	✓
Surface design	✓
Special colours	✓

Equipment and accessories

Tragschiene TS 35 Article No. 0111100635	Stahl verzinkt	  
Montageplatte Stahlblech Article No. 0112100600	Stahl verzinkt	  
Wandlaschen M6 (4 Stück) Article No. 0113100520	Edelstahl	  
Silikon Deckeldichtung Article No. 1980099999	Silikon	
Mastbefestigung MBFIX Article No. 0313000024	Edelstahl	  
Außenscharniere Alu (2 Stück) Article No. 0114000101	Aluminium pulverbeschichtet	  
EMV geschützte Ausführung Article No. 1980000119	-	
Tragschienenadapter TSFIX35 Article No. 0314000009	Polyamid 6 (PA6)	  
Schutzleiteranschluss Article No. 3000000051	Edelstahl	
Erdungsbolzen M6 Article No. 3000000169	Edelstahl	
Pulverbeschichtung gemäß DIN EN 45545-2:2016 für Bahnanwendungen Article No. 8600000010		



INDIVIDUALITY IS OUR STANDARD

With our extensive machinery and a highly motivated team, we transform our standard products into your individual solution.

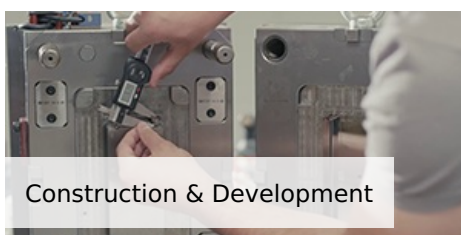
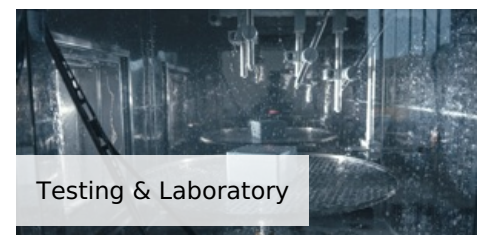
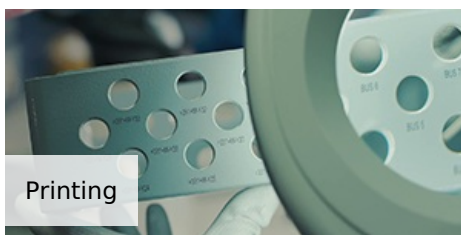

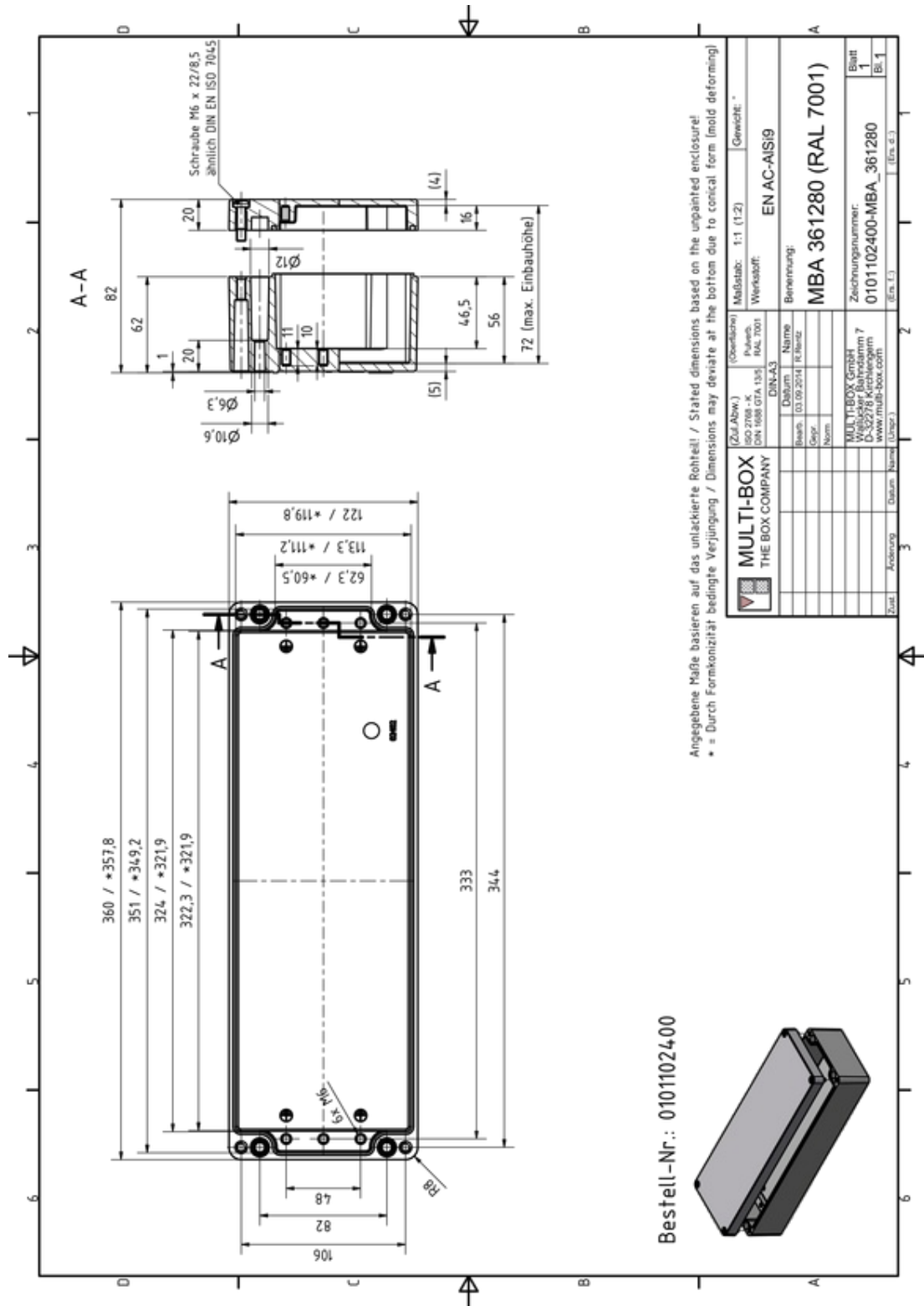

Bestell-Nr.: 0101102400

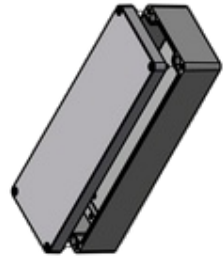

Under the following link you can download a higher resolution version of this drawing, including 3D construction data set:
<https://www.multi-box.com/gehaeuse/enclosures/industrial-enclosures/metal-enclosures/aluminium-enclosures/mba/mba-361280>