



## MBP 167555

Article No. 0201100500

Material: Polyester GRP

Protection class: IP66

MBP Enclosures are conform to the high standards required for applications within the mechanical engineering, shipbuilding, galvanic and petrochemical industry.

Besides good resistance to most solvents and acids, fibre glass reinforced Polyester is inflammable and self-extinguishing.

The enclosures are generally used as terminal enclosures or as command and information enclosures in chemically aggressive environments, such as refineries or road tunnels.



We would be glad to assist you!

### MULTI-BOX GmbH

Wallücker Bahndamm 7  
D-32278 Kirchlegern  
Tel. +49 (0)5223 49107-0

info@multi-box.com  
www.multi-box.com

### Dimensions and weight

Length (mm)	160
Width (mm)	75
Height (mm)	55
Weight (g)	366

### Color information

Color description cover	Light grey
RAL-code cover	7001
Color description base	Light grey
RAL-code base	7001

### Technical Drawings

PDF	
DXF	
3D	



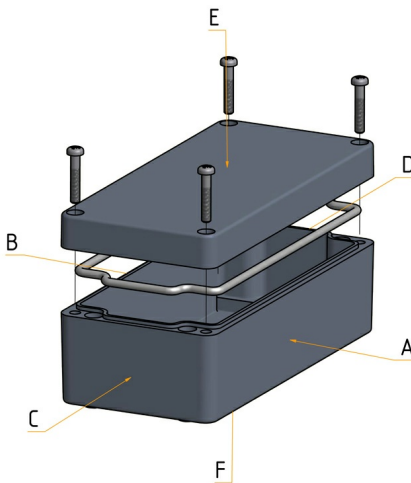

We would be glad to assist you!

**MULTI-BOX GmbH**

Wallücker Bahndamm 7  
D-32278 Kirchlegern  
Tel. +49 (0)5223 49107-0

info@multi-box.com  
www.multi-box.com



**Material information**

Material cover	Polyester GRP
Material base	Polyester GRP
Material sealing	EPDM
Material screws	Stainless Steel V2 A
Silicone-free	✓
Halogen-free	✓
Material UL listed	✓
UV-resistant	✓

**Temperature resistance and application areas**

Permanent operating temperature max. (°C)	110
Permanent operating temperature min. (°C)	-40
Permanent operating temperature with special sealing max. (°C)	140
Permanent operating temperature with special sealing min. (°C)	-50
Suitable for outdoor use	✓
Suitable for indoor use	✓

**Technical specifications**







Protection class IP	66
Norm of protection class	DIN EN 60529
Flame retardancy	V0
UL-Subject	UL 94
Fully insulated	✓
Captive cover screws	✓
Assembly tool	PZ2
Tightening torque cover screws max. (Nm)	3.00
Tightening torque cover screws min. (Nm)	1.50
Tightening torque earthing screw max. (Nm)	2.30
Tightening torque earthing screw min. (Nm)	1.20



### Modifications and Services

Mechanical processing	<input checked="" type="checkbox"/>
Finishing and Assembly	<input checked="" type="checkbox"/>
Surface design	<input checked="" type="checkbox"/>

### Equipment and accessories

Tragschiene TS 15 Article No. 0211100315	Stahl verzinkt	
Montageplatte Stahlblech Article No. 0212100300	Stahl verzinkt	  
Wandlaschen M4 (4 Stück) Article No. 0113100535	Edelstahl	  
Silikon Deckeldichtung Article No. 1980099999	Silikon	
EMV geschützte Ausführung Article No. 1980000118	-	
Tragschienenadapter TSFIX35 Article No. 0314000009	Polyamid 6 (PA6)	  
Erdungsbolzen M6 Article No. 3000000169	Edelstahl	



## INDIVIDUALITY IS OUR STANDARD

With our extensive machinery and a highly motivated team, we transform our standard products into your individual solution.



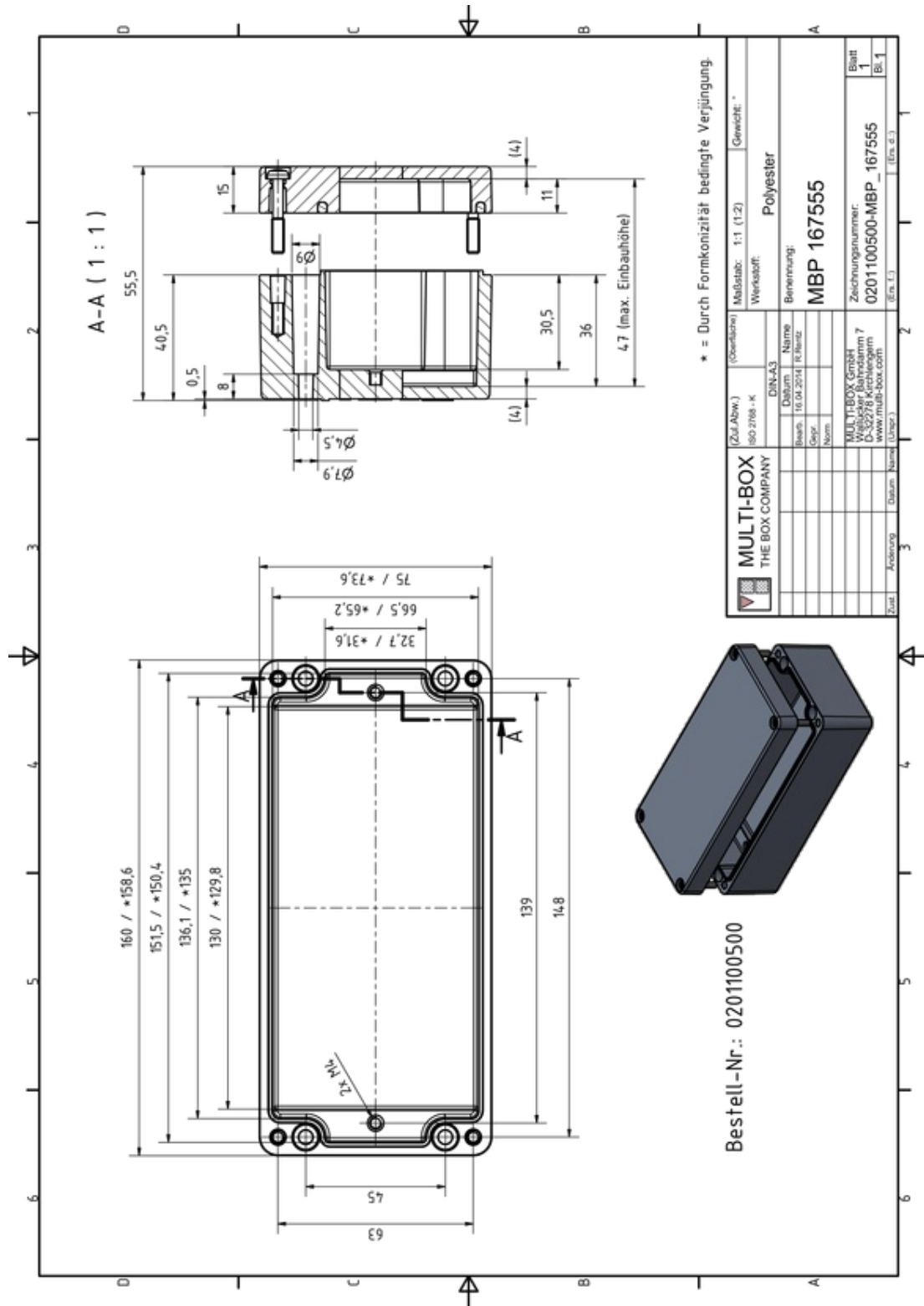

Under the following link you can download a higher resolution version of this drawing, including 3D construction data set:  
<https://www.multi-box.com/gehaeuse/enclosures/industrial-enclosures/plastic-enclosures/polyester-grp-enclosures/mbp/mbp-167555>